



K
RAIN®

Down here. Doing. It. Right

Table of Contents

ROTORS

Rotor Comparison Chart	5
MiniPro®	6
RPS™ 50	8
RPS™ 75	9
RPS™ 75i	12
RPS™ Select	16
ProPlus®	18
SuperPro®	20
ProSport®	24
TurfCup	24
Rotor Accessories	26

SPRAYS

Spray Body Comparison Chart	29
Pro-S™ Sprays	30
NP Sprays	32
K-Sprays	33
Spray Accessories	34

NOZZLES

Nozzle Comparison Chart	37
Rotary Nozzle Series	38
Fully Adjustable Rotary Nozzles	42
KVF Nozzles	44
KV Nozzles	46
Fixed Pattern Nozzles	48

DRIP, BUBBLERS

Bubblers	50
Drip Irrigation	51

ELECTRIC VALVES

Valve Comparison Chart	53
ProSeries 100 Valves	54
ProSeries 150 Valves	56
ProSeries 200 Valves	58
Valve Accessories	59

CONTROLLERS

Controller Comparison Chart	61
SiteMaster	62
PRO-EX3	64
PRO EX 2.0	66
PRO-LC	68
BLUE-LTE	70
K-Rain® BLUE®	71
RPS™ 46	72
Rain Sensor	73
PRO-TAP 100	74
Controller Accessories	75

PUMP START RELAYS

SINGLE STATION CONTROLLERS

INDEXING VALVES

4000 Series Indexing Valves	78
6000 Series Indexing Valves	79

RECLAIMED WATER (RCW) Series

Custom Products	82
Contractor Loyalty Program	83
Design Resources	84
Charts	85
Warranty	96



**It's our best warranty ever,
and no one else offers anything better.**

(See page 92 for detailed information)



**It's about hard work and teamwork and a relentless spirit.
It's about fifty plus years of every little thing mattering.**

It's not rocket science. Or is it?

Our story begins with a rocket scientist. A real rocket scientist. With a background in chemical engineering and a stint in the Army Artillery Corps Guided Missile School, Carl Kah Jr. helped develop early reusable rocket technology at Pratt & Whitney. That's NASA rocket technology (still in use today mind you).

With a natural born instinct for invention, Carl turned his attention to his own landscape irrigation system and thought, I can make it better. Call it: When science meets grass roots greatness. From the lathe in his garage, he designed and machined a valve that cycled zone-to-zone and eliminated the need for multiple valves. That creative inventiveness, or inventive creativity, led to patent number one in 1966.

With acres of ideas for greening up any size space, in 1970 Carl invented and patented a device he called Modulated Pressure Control. It allowed for the control of the entire irrigation system of a golf course without wires or tubes. The sale of that patent was the green light to incorporating K-Rain® Manufacturing in 1972.

Cultivating growth

Helping to grow the business from the ground up was son, Chip, who joined the company in 1986. Committed to engineering products that are reliable and eco-conscious, Chip led the development and growth of indexing valves for the wastewater disposal industry.

In 1991, Carl and Chip, always innovating, introduced the first of many patented gear drive rotors. Four years later, K-Rain® augmented the professional line by expanding its products into the retail market - taking the business to the next level.

Joining the burgeoning business that same year were Carl's two daughters, Gretchen and Deborah. Gretchen would lead growth in the west coast sales division. Deborah, an attorney, would be managing intellectual property and human resources. And in 2016, Chip's two sons, Christopher and Trevor, joined K-Rain® making it a 3rd generation company.

Green and Growing the Industry

Look across the industry and you'll find a little bit of K-Rain® innovation sprinkled into the competitive set. K-Rain® holds over 100 patents specific to irrigation including the three-spring reversing mechanism still used today in most gear-driven sprinklers.

Engineering the hardest-working irrigation products in the world is our heritage and our mission. Our commitment to quality is reflected in an ISO 9001 quality certification - the standard for manufacturing and process control.

We're also environmentally conscious about the materials we select and the products we produce. Sustainability is in our DNA. That's why we're an industry leader with a full range of products for reclaimed/recycled water.

Over 400 men and women make up the K-Rain® dream team, serving customers in the United States and more than 60 countries worldwide.

ROTORS



Rotors | Comparison Chart

From small landscapes to sports stadiums, K-Rain® has a rotor for every landscape. Designed and built to provide high performance and low maintenance year after year, K-Rain® rotors deliver outstanding coverage on any terrain. Enjoy a comprehensive range of innovative features and exceptional functionality.

	MiniPro®	RPS™50	RPS™75	RPS™75i	RPS™ Select	ProPlus®	SuperPro®	ProSport®
Specifications								
Inlet Size	1/2"	1/2"	3/4"	3/4"	3/4"	3/4"	3/4"	1"
Radius	18'-33'	18'-33'	22'-51'	26'-48'	33'-46'	22'-50'	26'-46'	43'-77'
Flow Range (GPM)	0.8-3.8	0.8-3.8	0.7-8.3	0.9-9.7	1.3-6.8	0.5-10.0	0.8-11.1	5.1-32.5
Features								
Operating Pressure range (PSI)	20-100	20-100	20-100	20-100	20-100	20-100	20-100	40-100
Recommended Pressure Range (PSI)	30-50	30-50	30-70	30-70	30-50	30-70	30-70	40-90
Nozzle Trajectory	25°	25°	26°	26°	24°	26°	26°	26°
Pre-installed Nozzles	#1.5	#1.5	#3.0	#2.5	4 built-in selectable	#2.5	#2.5	#10
Low Angle Nozzle Choices			11°	11°		12°	11°	
Non-Strippable Drive (arc memory clutch)						●	●	●
Arc Adjustment Range	40°-360°	40°-360°	40°-360°	40°-360°	40°-360°	40° to cont. 360°	40° to cont. 360°	40° to cont. 360°
Top Arc Set	●				●	●	●	●
Intelligent Flow Technology®				●			●	
Reclaimed Water Available	●	●	●	●	●	●	●	●
Stainless Steel Available			●	●				●
Optional or Factory Installed CV	●	●	●	●	●	●	●	Standard
Pressure Regulation Optional			●	●				
Customizable			●	●			●	
Warranty	7 years	7 years	7 years	7 years	7 years	7 years	7 years	7 years

Perfect for small lawn and landscape areas.

Features

- Revolutionary Patented Top Arc Set – Simplified arc set allows for wet or dry adjustment in seconds
- 1/2" Inlet – Replaces all standard mini rotors and pop-up sprays
- Adjustable to 360° – Full range of adjustment from 40° to 360°
- Patented Top Arc Set Degree Markings – Clearly indicates the current watering pattern and simplifies arc set adjustment
- Time Proven Patented Reversing Mechanism – Assures continuous reverse and return...over a 35 year history
- Rubber Cover – Seals out dirt and increases product durability
- Optional Check Valve – Prevents low head drainage

Specifications

- Arc Adjustment Range: 40° – 360°
- Flow Range: 0.8 – 3.8 GPM (3,0 – 14,4 LPM)
- Operating Pressure Range: 20 – 100 PSI (1,4 – 6,9 bar)
- Recommended Pressure Range: 30 – 50 PSI (2,1 – 3,4 bar)
- Precipitation Rate: 0.26 – 0.67 in/hr (7 – 17 mm/hr) (depending on spacing and nozzle used)
- Radius: 18' – 33' (5,5 – 10,1 m)
- Nozzle Trajectory: 25°

Easy Arc Setting

Arc Selection: 40° to 360°
Adjust from left start



Model

13003 4" (10,2 cm) MiniPro®

13006 6" (15,2 cm) MiniPro®

13012 12" (30,5 cm) MiniPro®

Accessories

See page 26–27

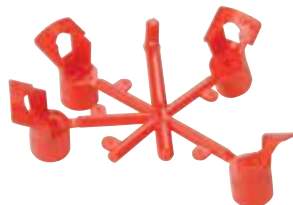

Fast Facts

ALL	INLET: 1/2" (1,3 CM) FEMALE THREAD NPT	
4"	Retracted height:	6" (15,2 cm)
	Riser height:	4" (10,2 cm)
6"	Retracted height:	8 3/8" (21,3 cm)
	Riser height:	6" (15,2 cm)
12"	Retracted height:	15 1/4" (38,7 cm)
	Riser height:	12" (30,5 cm)



Performance Data - U.S.

NOZZLE	PRESSURE	RADIUS	FLOW	PRECIP in/hr	
	PSI	FEET	GPM	■	▲
#0.75	30	18	0.8	0.48	0.55
	40	19	0.8	0.43	0.49
	50	20	0.9	0.43	0.50
#1.0	30	26	0.9	0.26	0.30
	40	27	1.2	0.32	0.37
	50	27	1.3	0.34	0.40
#1.5 Pre- Installed	30	27	1.5	0.40	0.46
	40	27	1.8	0.48	0.55
	50	28	2.0	0.49	0.57
#2.0	30	29	2.0	0.46	0.53
	40	30	2.3	0.49	0.57
	50	31	2.7	0.54	0.62
#3.0	30	32	3.0	0.56	0.65
	40	33	3.4	0.60	0.69
	50	33	3.8	0.67	0.78

Performance Data - Metric

NOZZLE	PRESSURE	RADIUS	FLOW	PRECIP mm/hr	
	BAR	METERS	L/M	■	▲
#0.75	2,1	5,5	3,0	12	14
	2,8	5,8	3,0	11	13
	3,4	6,1	3,4	11	13
#1.0	2,1	7,9	3,4	7	8
	2,8	8,2	4,5	8	9
	3,4	8,2	4,9	9	10
#1.5 Pre- Installed	2,1	8,2	5,7	10	12
	2,8	8,2	6,8	12	14
	3,4	8,5	7,6	12	14
#2.0	2,1	8,8	7,6	12	13
	2,8	9,1	8,7	12	14
	3,4	9,4	10,2	14	16
#3.0	2,1	9,8	11,4	14	17
	2,8	10,1	12,9	15	18
	3,4	10,1	14,4	17	20

*All precipitation rates calculated for 180° operation.
For the precipitation rate for a 360° sprinkler, divide by 2.

How to Specify with Options

MODELS	OPTIONS
13003	-CV ▶ Check Valve
13006	-NN ▶ No Nozzle
13012	-RCW ▶ Reclaimed Water Use

Examples: 13003-NN, 13006-RCW-CV



RPS™ 50

Designed for smaller landscape areas.

Features

- Right Position Start
- Patented Reversing Mechanism – Continuous reverse and return
- Ideal for use in tandem with larger rotors
- Rubber Cover – Seals out dirt and increases product durability
- Comes with 5 Nozzles for system flexibility
- Optional Check Valve – Prevents low head drainage

Specifications

- Arc Adjustment Range: 40° – 360°
- Flow Range: 0.8 – 3.8 GPM (3,0 – 14,4 LPM)
- Operating Pressure Range: 20 – 100 PSI (1,4 – 6,9 bar)
- Recommended Pressure Range: 30 – 50 PSI (2,1 – 3,4 bar)
- Precipitation Rate: 0.26 – 0.67 in/hr (7 – 17 mm/hr (depending on spacing and nozzle used)
- Radius: 18' – 33' (5,5 – 10,1 m)
- Nozzle Trajectory: 25°

Easy Arc Setting

Arc Selection: 40° to 360°
Adjust from right start



Model

RPS50 RPS™ 50

Accessories

See page 26-27

Fast Facts

INLET: 1/2" (1,3 CM) FEMALE THREAD NPT

Retracted height:	6" (15,2 cm)
Riser height:	4" (10,2 cm)

How to Specify

MODELS	OPTIONS
RPS50	-CV ▶ Check Valve
	-RCW ▶ Reclaimed Water Use

Examples: RPS50-CV



Performance Data - U.S.

NOZZLE	PRESSURE	RADIUS	FLOW	PRECIP in/hr	
	PSI	FEET	GPM	■	▲
#0.75	30	18	0.8	0.48	0.55
	40	19	0.8	0.43	0.49
	50	20	0.9	0.43	0.50
#1.0	30	26	0.9	0.26	0.30
	40	27	1.2	0.32	0.37
	50	27	1.3	0.34	0.40
#1.5 Pre- Installed	30	27	1.5	0.40	0.46
	40	27	1.8	0.48	0.55
	50	28	2.0	0.49	0.57
#2.0	30	29	2.0	0.46	0.53
	40	30	2.3	0.49	0.57
	50	31	2.7	0.54	0.62
#3.0	30	32	3.0	0.56	0.65
	40	33	3.4	0.60	0.69
	50	33	3.8	0.67	0.78

Performance Data - Metric

NOZZLE	PRESSURE	RADIUS	FLOW	PRECIP mm/hr	
	BAR	METERS	L/M	■	▲
#0.75	2,1	5,5	3,0	12	14
	2,8	5,8	3,0	11	13
	3,4	6,1	3,4	11	13
#1.0	2,1	7,9	3,4	7	8
	2,8	8,2	4,5	8	9
	3,4	8,2	4,9	9	10
#1.5 Pre- Installed	2,1	8,2	5,7	10	12
	2,8	8,2	6,8	12	14
	3,4	8,5	7,6	12	14
#2.0	2,1	8,8	7,6	12	13
	2,8	9,1	8,7	12	14
	3,4	9,4	10,2	14	16
#3.0	2,1	9,8	11,4	14	17
	2,8	10,1	12,9	15	18
	3,4	10,1	14,4	17	20

*All precipitation rates calculated for 180° operation.
For the precipitation rate for a 360° sprinkler, divide by 2.

Sets the standard for 3/4" gear-driven rotors.

Features

- Right Position Start
- Patented Reversing Mechanism – Continuous reverse and return
- Full and Part Circle Rotation – Provides a full range of adjustment from 40° to 360°
- Non-flushing Wiper Seal – Reduces leaks caused by debris trapped under seal
- 3/4" (1,9 cm) Inlet – Replaces all standard rotors
- Rubber Cover – Seals out dirt and increases durability
- Wide Selection of Nozzles – Including standard and low angle for flexibility in system design
- Includes 5 Free Check Valve Assemblies Per Box
- Universal Riser Assembly – Fits into existing Hunter® PGP® and PGP® Ultra cans
- Pressure Regulated – 45 PSI available (6" only)

Specifications

- Arc Adjustment Range: 40° – 360°
- Flow Range: 0.7 – 8.3 GPM (2,6 – 31 LPM)
- Operating Pressure Range: 20 – 100 PSI (1,4 – 6,9 bar)
- Recommended Pressure RRange: 30 – 70 PSI (2,1 – 4,8 bar)
- Precipitation Rate: .16 – 1.0 in/hr (4 – 25,4 mm/hr) (depending on spacing and nozzle used)
- Radius: 22' – 51' (6,7 – 15,5 m)
- Nozzle Trajectory: 26°
- Low Angle Nozzle Trajectory: 11°
- 8 Standard and 4 Low Angle Nozzles Included

Easy Arc Setting

Arc Selection: 40° to 360°
Adjust from right start



Accessories

See page 26-27



Fast Facts

ALL	INLET: 3/4" (1,9 CM) FEMALE THREAD NPT	
4"	Retracted height:	7 3/8" (19,7 cm)
	Riser height:	4 3/8" (11,1 cm)
6"	Retracted height:	9 1/2" (24,1 cm)
	Riser height:	6 3/8" (16,2 cm)
Shrub	Height:	7 1/2" (19,1 cm)



Models

RPS75	RPS™ 75 Rotor
RPS75-360	RPS™ 75 Rotor, 360°
RPS75-SH	RPS™ 75 Rotor, Shrub
RPS75-360-SH	RPS™ 75 Rotor, 360°, Shrub
RPS75-6INCH	RPS™ 75 Rotor 6" (15,2 cm)

How to Specify with Options

MODELS	OPTIONS
RPS75	-SS ▶ Stainless Steel
RPS75-360	-CV ▶ Check Valve
RPS75-SH	-NN ▶ No Nozzle
RPS75-360-SH	-RCW ▶ Reclaimed Water Use
RPS75-6inch	-PR ▶ Pressure Regulation (6"only)

Examples: RPS75-SS, RPS75-360-RCW-CV

Performance Data - U.S.

NOZZLE	PRESSURE		RADIUS		FLOW		PRECIP in/hr	
	PSI	FEET	GPM	■	▲			
#.75	30	29	0.7	0.16	0.19			
	40	30	0.8	0.17	0.20			
	50	30	0.9	0.19	0.22			
	60	31	1.0	0.20	0.23			
#1.0	30	30	0.9	0.19	0.22			
	40	31	1.0	0.20	0.23			
	50	31	1.2	0.24	0.28			
	60	32	1.3	0.24	0.28			
#1.5	30	32	1.2	0.23	0.26			
	40	33	1.4	0.25	0.29			
	50	34	1.6	0.27	0.31			
	60	34	1.8	0.30	0.35			
#2.0	30	34	1.6	0.27	0.31			
	40	36	1.8	0.27	0.31			
	50	38	2.0	0.27	0.31			
	60	38	2.2	0.29	0.34			
#3.0 Pre- Installed	30	36	2.0	0.30	0.34			
	40	38	2.4	0.32	0.37			
	50	40	2.7	0.32	0.38			
	60	40	2.9	0.35	0.40			
#4.0	30	36	2.6	0.39	0.45			
	40	40	3.0	0.36	0.42			
	50	42	3.4	0.37	0.43			
	60	42	3.7	0.40	0.47			
#6.0	40	38	4.2	0.56	0.65			
	50	43	4.9	0.51	0.59			
	60	46	5.5	0.50	0.58			
	70	47	6.0	0.52	0.60			
#8.0	40	45	6.0	0.57	0.66			
	50	48	6.8	0.57	0.66			
	60	49	7.6	0.61	0.70			
	70	51	8.2	0.61	0.70			

PR Performance Data - U.S.

NOZZLE	PRESSURE		RADIUS		FLOW		PRECIP in/hr	
	PSI	FEET	GPM	■	▲			
#.75	30	29	0.7	0.16	0.19			
	40	30	0.8	0.17	0.20			
	50	30	0.9	0.19	0.22			
	60	30	0.9	0.19	0.22			
#1.0	30	30	0.9	0.19	0.22			
	40	31	1.0	0.20	0.23			
	50	31	1.2	0.24	0.28			
	60	31	1.2	0.24	0.28			
#1.5	30	32	1.2	0.23	0.26			
	40	33	1.4	0.25	0.29			
	50	34	1.6	0.27	0.31			
	60	34	1.6	0.27	0.31			
#2.0	30	34	1.6	0.27	0.31			
	40	36	1.8	0.27	0.31			
	50	38	2.0	0.27	0.31			
	60	38	2.0	0.27	0.31			
#3.0 Pre- Installed	30	36	2.0	0.30	0.34			
	40	38	2.4	0.32	0.37			
	50	40	2.7	0.32	0.38			
	60	40	2.7	0.32	0.38			
#4.0	30	36	2.6	0.39	0.45			
	40	40	3.0	0.36	0.42			
	50	42	3.4	0.37	0.43			
	60	42	3.4	0.37	0.43			
#6.0	40	38	4.2	0.56	0.65			
	50	43	4.9	0.51	0.59			
	60	43	4.9	0.51	0.59			
	70	43	4.9	0.51	0.59			
#8.0	40	45	6.0	0.57	0.66			
	50	48	6.8	0.57	0.66			
	60	48	6.8	0.57	0.66			
	70	48	6.8	0.57	0.66			

Low Angle Performance Data - U.S.

NOZZLE	PRESSURE		RADIUS		FLOW		PRECIP in/hr	
	PSI	FEET	GPM	■	▲			
#1.0	30	22	1.2	0.48	0.55			
	40	24	1.7	0.57	0.66			
	50	26	1.8	0.51	0.59			
	60	28	2.0	0.49	0.57			
#3.0	30	29	3.0	0.69	0.79			
	40	32	3.1	0.58	0.67			
	50	35	3.5	0.55	0.64			
	60	37	3.8	0.53	0.62			
#4.0	30	31	3.4	0.68	0.79			
	40	34	3.9	0.65	0.75			
	50	37	4.4	0.62	0.71			
	60	38	4.7	0.63	0.72			
#6.0	40	38	6.5	0.87	1.00			
	50	40	7.3	0.88	1.01			
	60	42	8.0	0.87	1.01			
	70	44	8.6	0.86	0.99			

PR Low Angle Performance Data - U.S.

NOZZLE	PRESSURE		RADIUS		FLOW		PRECIP in/hr	
	PSI	FEET	GPM	■	▲			
#1.0	30	22	1.2	0.48	0.55			
	40	24	1.7	0.57	0.66			
	50	26	1.8	0.51	0.59			
	60	26	1.8	0.51	0.59			
#3.0	30	29	3.0	0.69	0.79			
	40	32	3.1	0.58	0.67			
	50	35	3.5	0.55	0.64			
	60	35	3.5	0.55	0.64			
#4.0	30	31	3.4	0.68	0.79			
	40	34	3.9	0.65	0.75			
	50	37	4.4	0.62	0.71			
	60	37	4.4	0.62	0.71			
#6.0	40	38	6.5	0.87	1.00			
	50	40	7.3	0.88	1.01			
	60	40	7.3	0.88	1.01			
	70	40	7.3	0.88	1.01			

*All precipitation rates calculated for 180° operation. For the precipitation rate for a 360° sprinkler, divide by 2.



WATCH VIDEO

Performance Data - Metric

NOZZLE	PRESSURE		RADIUS		FLOW		PRECIP mm/hr	
	BAR	METERS	L/M	■	▲			
#.75	2,1	8,8	2,6	4	5			
	2,8	9,1	3,0	4	5			
	3,4	9,1	3,4	5	6			
	4,1	9,4	3,8	5	6			
#1.0	2,1	9,1	3,4	5	6			
	2,8	9,4	3,8	5	6			
	3,4	9,4	4,5	6	7			
	4,1	9,8	4,9	6	7			
#1.5	2,1	9,8	4,5	6	7			
	2,8	10,1	5,3	6	7			
	3,4	10,4	6,1	7	8			
	4,1	10,4	6,8	8	9			
#2.0	2,1	10,4	6,1	7	8			
	2,8	11,0	6,8	7	8			
	3,4	11,6	7,6	7	8			
	4,1	11,6	8,3	7	9			
#3.0 Pre- Installed	2,1	11,0	7,6	8	9			
	2,8	11,6	9,1	8	9			
	3,4	12,2	10,2	8	10			
	4,1	12,2	11,0	9	10			
#4.0	2,1	11,0	9,8	10	11			
	2,8	12,2	11,4	9	11			
	3,4	12,8	12,9	9	11			
	4,1	12,8	14,0	10	12			
#6.0	2,8	11,6	15,9	14	16			
	3,4	13,1	18,5	13	15			
	4,1	14,0	18,5	13	15			
	4,8	14,3	18,5	13	15			
#8.0	2,8	13,7	22,7	14	17			
	3,4	14,6	25,7	14	17			
	4,1	14,9	25,7	15	18			
	4,8	15,5	25,7	15	18			

PR Performance Data - Metric

NOZZLE	PRESSURE		RADIUS		FLOW		PRECIP mm/hr	
	BAR	METERS	L/M	■	▲			
#.75	2,1	8,8	2,7	7	8			
	2,8	9,1	3,0	7	8			
	3,5	9,1	3,4	8	9			
	4,1	9,1	3,4	8	9			
#1.0	2,1	9,1	3,4	8	9			
	2,8	9,4	3,8	8	9			
	3,5	9,4	4,5	10	11			
	4,1	9,4	4,5	10	11			
#1.5	2,1	9,8	4,5	9	11			
	2,8	10,1	5,3	10	12			
	3,5	10,4	6,1	11	13			
	4,1	10,4	6,1	11	13			
#2.0	2,1	10,4	6,1	11	13			
	2,8	11,0	6,8	11	13			
	3,5	11,6	7,6	11	13			
	4,1	11,6	7,6	11	13			
#3.0 Pre- Installed	2,1	11,0	7,6	12	14			
	2,8	11,6	9,1	13	15			
	3,5	12,2	10,2	13	15			
	4,1	12,2	10,2	13	15			
#4.0	2,1	11,0	9,9	16	18			
	2,8	12,2	11,4	15	17			
	3,5	12,8	12,9	15	17			
	4,1	12,8	12,9	15	17			
#6.0	2,8	11,6	15,9	23	26			
	3,5	13,1	18,6	21	24			
	4,1	13,1	18,6	21	24			
	4,8	13,1	18,6	21	24			
#8.0	2,8	13,7	22,7	23	27			
	3,5	14,6	25,8	23	27			
	4,1	14,6	25,8	23	27			
	4,8	14,6	25,8	23	27			

Low Angle Performance Data - Metric

NOZZLE	PRESSURE		RADIUS		FLOW		PRECIP mm/hr	
	BAR	METERS	L/M	■	▲			
#1.0	2,1	6,7	4,5	12	14			
	2,8	7,3	6,4	14	17			
	3,4	7,9	6,8	13	15			
	4,1	8,5	7,6	12	14			
#3.0	2,1	8,8	11,4	18	20			
	2,8	9,8	11,7	15	17			
	3,4	10,7	13,2	14	16			
	4,1	11,3	13,2	13	16			
#4.0	2,1	9,4	12,9	17	20			
	2,8	10,4	14,8	17	19			
	3,4	11,3	16,7	16	18			
	4,1	11,6	17,8	16	18			
#6.0	2,8	11,6	24,6	22	25			
	3,4	12,2	27,6	22	26			
	4,1	12,8	27,6	22	26			
	4,8	13,4	27,6	22	25			

PR Low Angle Performance Data - Metric

NOZZLE	PRESSURE		RADIUS		FLOW		PRECIP mm/hr	
	BAR	METERS	L/M	■	▲			
#1.0	2,1	6,7	4,5	19	22			
	2,8	7,3	6,4	23	27			
	3,5	7,9	6,8	21	24			
	4,1	7,9	6,8	21	24			
#3.0	2,1	8,8	11,4	28	32			
	2,8	9,8	11,7	24	27			
	3,5	10,7	13,3	22	26			
	4,1	10,7	13,3	22	26			
#4.0	2,1	9,5	12,9	28	32			
	2,8	10,4	14,8	26	31			
	3,5	11,3	16,7	25	29			
	4,1	11,3	16,7	25	29			
#6.0	2,8	11,6	24,6	35	41			
	3,5	12,2	27,7	36	41			
	4,1	12,2	27,7	36	41			
	4,8	12,2	27,7	36	41			

*All precipitation rates calculated for 180° operation. For the precipitation rate for a 360° sprinkler, divide by 2.



RPS™ 75i

With Patented Intelligent Flow Technology®.

Features

- Right position start
- Patented Intelligent Flow Technology® – Reduce distance and water flow simultaneously and proportionately
- Shut off flow from the head
- Patented Reversing Mechanism – Continuous reverse and return
- Wide Selection of Nozzles – Including standard and low angle for flexibility in system design
- Rugged RPS Family Construction and features
- Superior Uniformity, Conserves Water, Fewer Zones Required
- Save Time on Every Project – New or retrofit
- Includes 5 Free Check Valve Assemblies Per Box
- Universal Riser Assembly – Fits into existing Hunter® PGP® and PGP® Ultra cans
- Pressure Regulated – 45 PSI available (6" only)

Specifications

- Arc Adjustment Range: 40° – 360°
- Flow Range: 0.6 – 9.7 GPM (2,3 – 36,7 LPM)
- Operating Pressure Range: 20 – 100 PSI (1,4 – 6,9 bar)
- Recommended Pressure RRange: 30 – 70 PSI (2,1 – 4,8 bar)
- Precipitation Rate: 0.22 – 1.40 in/hr (6 – 35 mm/hr)
- Radius: 18' – 48' (5,6 – 14,6 m)
- Nozzle Trajectory: 26°
- Low Angle Nozzle Trajectory: 11°
- Nozzles Included: 8 Standard, 4 Low Angle

Models

- | | |
|----------------------|-----------------------------|
| RPS 75i | RPS™ 75i Rotor |
| RPS75i-360 | RPS™ 75i Rotor, 360° |
| RPS75i-SH | RPS™ 75i Rotor, Shrub |
| RPS75i-360-SH | RPS™ 75i Rotor, Shrub, 360° |
| RPS75i-6INCH | RPS™ 75i Rotor 6" (15,2 cm) |

Accessories

See page 26-27

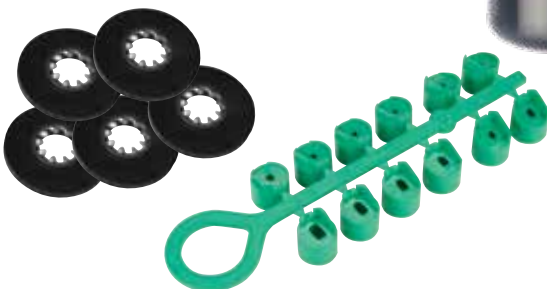

Fast Facts

ALL	INLET: 3/4" (1,9 CM) FEMALE THREAD NPT
4"	Retracted height: 7 3/8" (19,7 cm) Riser height: 4 1/4" (10,8 cm)
6"	Retracted height: 9 1/2" (24,1 cm) Riser height: 6 1/4" (15,9 cm)
Shrub	Height: 7 1/2" (19,1 cm)



How to Specify with Options

MODELS	OPTIONS
RPS75i	-SS ▶ Stainless Steel
RPS75i-360	-CV ▶ Check Valve
RPS75i-SH	-NN ▶ No Nozzle
RPS75i-360-SH	-RCW ▶ Reclaimed Water Use
RPS75i-6inch	-PR ▶ Pressure Regulation (6"only)

Examples: RPS75i-NN, RPS75-360-RCW



Intelligent Flow Technology®

- Reduces distance and flow rate simultaneously and proportionately
- Provides full on/off control



WATCH VIDEO



Performance Data - U.S.

NOZZLE	NO ADJUSTMENT					-30% ADJUSTMENT			
	PRESSURE	RADIUS	FLOW	PRECIP in/hr		RADIUS	FLOW	PRECIP in/hr	
	PSI	FEET	GPM	■	▲	FEET	GPM	■	▲
#1.0	30	31	1.1	0.22	0.25	22	0.8	0.31	0.36
	40	32	1.4	0.26	0.30	22	1.0	0.38	0.43
	50	33	1.6	0.28	0.33	23	1.1	0.40	0.47
	60	34	1.8	0.30	0.35	24	1.3	0.43	0.49
#1.5	30	33	1.5	0.27	0.31	23	1.1	0.38	0.44
	40	35	1.8	0.28	0.33	25	1.3	0.40	0.47
	50	35	2.0	0.31	0.36	25	1.4	0.45	0.52
	60	36	2.2	0.33	0.38	25	1.5	0.47	0.54
#2.0	30	33	1.8	0.32	0.37	23	1.3	0.45	0.52
	40	34	2.1	0.35	0.40	24	1.5	0.50	0.58
	50	36	2.4	0.36	0.41	25	1.7	0.51	0.59
	60	38	2.7	0.36	0.42	27	1.9	0.51	0.59
#2.5 Pre- Installed	30	35	2.2	0.35	0.40	25	1.5	0.49	0.57
	40	38	2.6	0.35	0.40	27	1.8	0.50	0.57
	50	39	3.0	0.38	0.44	27	2.1	0.54	0.63
	60	40	3.3	0.40	0.46	28	2.3	0.57	0.65
#3.0	30	38	2.7	0.36	0.42	27	1.9	0.51	0.59
	40	40	3.1	0.37	0.43	28	2.2	0.53	0.62
	50	41	3.5	0.40	0.46	29	2.5	0.57	0.66
	60	41	3.9	0.45	0.52	29	2.7	0.64	0.74
#4.0	30	38	3.5	0.47	0.54	27	2.5	0.67	0.77
	40	40	4.0	0.48	0.56	28	2.8	0.69	0.79
	50	43	4.4	0.46	0.53	30	3.1	0.65	0.76
	60	43	4.9	0.51	0.59	30	3.4	0.73	0.84
#5.0	30	43	4.4	0.46	0.53	30	3.1	0.65	0.76
	40	43	5.0	0.52	0.60	30	3.5	0.74	0.86
	50	44	5.5	0.55	0.63	31	3.9	0.78	0.90
	60	42	5.9	0.64	0.74	29	4.1	0.92	1.06
#6.0	30	40	5.0	0.60	0.70	28	3.5	0.86	0.99
	40	43	5.9	0.61	0.71	30	4.1	0.88	1.01
	50	43	6.6	0.69	0.79	30	4.6	0.98	1.13
	60	44	7.3	0.73	0.84	31	5.1	1.04	1.20
#8.0	30	43	6.8	0.71	0.82	32	5.5	1.06	1.22
	40	47	7.9	0.69	0.80	30	4.8	1.01	1.17
	50	48	8.8	0.74	0.85	33	5.5	0.98	1.14
	60	47	9.7	0.85	0.98	34	6.2	1.05	1.21
#8.0	60	47	9.7	0.85	0.98	33	6.8	1.21	1.39
	70	50	10.2	0.79	0.91	35	7.1	1.12	1.3

PR Performance Data - U.S.

NOZZLE	NO ADJUSTMENT					-30% ADJUSTMENT			
	PRESSURE	RADIUS	FLOW	PRECIP in/hr		RADIUS	FLOW	PRECIP in/hr	
	PSI	FEET	GPM	■	▲	FEET	GPM	■	▲
#1.0	30	31	1.1	0.22	0.25	22	0.8	0.31	0.36
	40	32	1.4	0.26	0.30	22	1.0	0.38	0.43
	50	33	1.6	0.28	0.33	23	1.1	0.40	0.47
	60	33	1.6	0.28	0.33	23	1.1	0.40	0.47
#1.5	30	33	1.5	0.27	0.31	23	1.1	0.38	0.44
	40	35	1.8	0.28	0.33	25	1.3	0.40	0.47
	50	35	2.0	0.31	0.36	25	1.4	0.45	0.52
	60	35	2.0	0.31	0.36	25	1.4	0.45	0.52
#2.0	30	33	1.8	0.32	0.37	23	1.3	0.45	0.52
	40	34	2.1	0.35	0.40	24	1.5	0.50	0.58
	50	36	2.4	0.36	0.41	25	1.7	0.51	0.59
	60	36	2.4	0.36	0.41	27	1.9	0.51	0.59
#2.5 Pre- Installed	30	35	2.2	0.35	0.40	25	1.5	0.49	0.57
	40	38	2.6	0.35	0.40	27	1.8	0.50	0.57
	50	39	3.0	0.38	0.44	27	2.1	0.54	0.63
	60	39	3.0	0.38	0.44	28	2.3	0.57	0.65
#3.0	30	38	2.7	0.36	0.42	27	1.9	0.51	0.59
	40	40	3.1	0.37	0.43	28	2.2	0.53	0.62
	50	41	3.5	0.40	0.46	29	2.5	0.57	0.66
	60	41	3.5	0.40	0.46	29	2.7	0.64	0.74
#4.0	30	38	3.5	0.47	0.54	27	2.5	0.67	0.77
	40	40	4.0	0.48	0.56	28	2.8	0.69	0.79
	50	43	4.4	0.46	0.53	30	3.1	0.65	0.76
	60	43	4.4	0.46	0.53	30	3.4	0.73	0.84
#5.0	30	43	4.4	0.46	0.53	30	3.1	0.65	0.76
	40	43	5.0	0.52	0.60	30	3.5	0.74	0.86
	50	44	5.5	0.55	0.63	31	3.9	0.78	0.90
	60	44	5.5	0.55	0.63	29	4.1	0.92	1.06
#6.0	30	40	5.0	0.60	0.69	28	3.5	0.86	0.99
	40	43	5.9	0.61	0.71	30	4.1	0.88	1.01
	50	43	6.6	0.69	0.79	30	4.6	0.98	1.13
	60	43	6.6	0.69	0.79	31	5.1	1.04	1.20
#8.0	30	43	6.8	0.71	0.82	32	5.5	1.06	1.22
	40	47	7.9	0.69	0.80	30	4.8	1.01	1.17
	50	48	8.8	0.74	0.85	33	5.5	0.98	1.14
	60	48	8.8	0.74	0.85	34	6.2	1.05	1.21
#8.0	60	48	8.8	0.74	0.85	33	6.8	1.21	1.39
	70	48	8.8	0.74	0.85	35	7.1	1.12	1.3

Low Angle Performance Data - U.S.

NOZZLE	NO ADJUSTMENT					-30% ADJUSTMENT			
	PRESSURE	RADIUS	FLOW	PRECIP in/hr		RADIUS	FLOW	PRECIP in/hr	
	PSI	FEET	GPM	■	▲	FEET	GPM	■	▲
#1.0	30	26	0.9	0.25	0.29	18	0.6	0.37	0.42
	40	27	1.0	0.26	0.31	19	0.7	0.38	0.44
	50	27	1.2	0.32	0.37	19	0.8	0.45	0.52
	60	26	1.4	0.4	0.46	18	1	0.57	0.66
#1.5	30	28	1.3	0.32	0.37	20	0.9	0.46	0.53
	40	29	1.5	0.34	0.4	20	1.1	0.49	0.57
	50	30	1.7	0.36	0.42	21	1.2	0.52	0.6
	60	31	1.9	0.38	0.44	22	1.3	0.54	0.63
#2.0	30	29	1.9	0.44	0.5	20	1.3	0.62	0.72
	40	32	2.2	0.41	0.48	22	1.5	0.59	0.68
	50	33	2.5	0.44	0.51	23	1.8	0.63	0.73
	60	34	2.8	0.47	0.54	24	2	0.67	0.77
#3.0	30	32	2.5	0.47	0.54	22	1.8	0.67	0.78
	40	34	3.0	0.5	0.58	24	2.1	0.71	0.82
	50	35	3.5	0.55	0.64	25	2.5	0.79	0.91
	60	36	4.0	0.59	0.69	25	2.8	0.85	0.98

PR Low Angle Performance Data - U.S.

NOZZLE	NO ADJUSTMENT					-30% ADJUSTMENT			
	PRESSURE	RADIUS	FLOW	PRECIP in/hr		RADIUS	FLOW	PRECIP in/hr	
	PSI	FEET	GPM	■	▲	FEET	GPM	■	▲
#1.0	30	26	0.9	0.26	0.26	18	0.6	0.37	0.42
	40	27	1.0	0.26	0.26	19	0.7	0.38	0.44
	50	27	1.2	0.32	0.32	19	0.8	0.45	0.52
	60	26	1.2	0.34	0.34	18	0.8	0.49	0.56
#1.5	30	28	1.3	0.32	0.32	20	0.9	0.46	0.53
	40	29	1.5	0.34	0.34	20	1.1	0.49	0.57
	50	30	1.7	0.36	0.36	21	1.2	0.52	0.60
	60	30	1.7	0.36	0.36	21	1.2	0.52	0.60
#2.0	30	29	1.9	0.43	0.43	20	1.3	0.62	0.72
	40	32	2.2	0.41	0.41	22	1.5	0.59	0.68
	50	33	2.5	0.44	0.44	23	1.8	0.63	0.73
	60	33	2.5	0.44	0.44	23	1.8	0.63	0.73
#3.0	30	32	2.5	0.47	0.47	22	1.8	0.67	0.78
	40	34	3.0	0.50	0.50	24	2.1	0.71	0.82
	50	35	3.5	0.55	0.55	25	2.5	0.79	0.91
	60	35	3.5	0.55	0.55	25	2.5	0.79	0.91

*All precipitation rates calculated for 180° operation. For the precipitation rate for a 360° sprinkler, divide by 2.

Performance Data – Metric

NOZZLE	NO ADJUSTMENT					-30% ADJUSTMENT			
	PRESSURE	RADIUS	FLOW	PRECIP mm/hr		RADIUS	FLOW	PRECIP mm/hr	
	BAR	METER	L/M	■	▲	METER	L/M	■	▲
#1,0	2,1	9,4	4,2	6	6	7	2,9	8	9
	2,8	9,8	5,3	7	8	7	3,7	10	11
	3,4	10,1	6,1	7	8	7	4,2	10	12
	4,1	10,4	6,8	8	9	7	4,8	11	12
#1,5	2,1	10,1	5,7	7	8	7	4,0	10	11
	2,8	10,7	6,8	7	8	8	4,8	10	12
	3,4	10,7	7,6	7	9	8	5,3	11	13
	4,1	11,0	8,3	8	10	8	5,8	12	14
#2,0	2,1	10,1	6,8	7	9	7	4,8	11	13
	2,8	10,4	7,9	7	10	7	5,6	13	15
	3,4	11,0	9,1	8	10	8	6,4	13	15
	4,1	11,6	10,2	8	11	8	7,2	13	15
#2,5 Pre- Installed	2,1	10,7	8,3	7	10	8	5,8	12	14
	2,8	11,6	9,8	9	10	8	6,9	13	15
	3,4	11,9	11,4	10	11	8	7,9	14	16
	4,1	12,2	12,5	10	12	9	8,7	14	17
#3,0	2,1	11,6	10,2	9	11	8	7,2	13	15
	2,8	12,2	11,7	9	11	9	8,2	13	16
	3,4	12,5	13,3	10	12	9	9,3	14	17
	4,1	12,5	14,8	11	13	9	10,3	16	19
#4,0	2,1	11,6	13,3	12	14	8	9,3	17	20
	2,8	12,2	15,1	12	14	9	10,6	18	20
	3,4	13,1	16,7	12	13	9	11,7	17	19
	4,1	13,1	18,5	13	15	9	13,0	19	21
#5,0	2,1	13,1	16,7	12	13	9	11,7	17	19
	2,8	13,1	18,9	13	15	9	13,2	19	22
	3,4	13,4	20,8	14	16	9	14,6	20	23
	4,1	12,8	22,3	16	19	9	15,6	23	27
#6,0	2,1	12,2	18,9	15	18	9	13,2	22	25
	2,8	13,1	22,3	16	18	9	15,6	22	26
	3,4	13,1	25,0	17	20	9	17,5	25	29
	4,1	13,4	27,6	18	21	9	19,3	26	30
#8,0	4,8	13,7	29,5	19	22	10	20,7	27	31
	2,1	13,1	25,7	18	21	9	18,0	26	30
	2,8	14,3	29,9	17	20	10	20,9	25	29
	3,4	14,6	33,3	19	22	10	23,3	27	31
#8,0	4,1	14,3	36,7	21	25	10	25,7	31	35
	4,8	15,2	38,6	20	23	11	27,0	29	33

PR Performance Data – Metric

NOZZLE	NO ADJUSTMENT					-30% ADJUSTMENT			
	PRESSURE	RADIUS	FLOW	PRECIP mm/hr		RADIUS	FLOW	PRECIP mm/hr	
	BAR	METER	L/M	■	▲	METER	L/M	■	▲
#1,0	2,1	9,4	4,2	6	6	6,6	2,9	8	9
	2,8	9,8	5,3	7	8	6,8	3,7	10	11
	3,5	10,1	6,1	7	8	7,0	4,2	10	12
	4,1	10,1	6,1	7	8	7,0	4,2	10	13
#1,5	2,1	10,1	5,7	7	8	7,0	4,0	10	11
	2,8	10,7	6,8	7	8	7,5	4,8	10	12
	3,5	10,7	7,6	8	9	7,5	5,3	11	13
	4,1	10,7	7,6	8	9	7,5	5,3	11	13
#2,0	2,1	10,1	6,8	8	9	7,0	4,8	12	13
	2,8	10,4	7,9	9	10	7,3	5,6	13	15
	3,5	11,0	9,1	9	10	7,7	6,4	13	15
	4,1	11,0	9,1	9	10	7,7	6,4	13	15
#2,5 Pre- Installed	2,1	10,7	8,3	9	10	7,5	5,8	13	15
	2,8	11,6	9,8	9	10	8,1	6,9	13	15
	3,5	11,9	11,4	10	11	8,3	7,9	14	16
	4,1	11,9	11,4	10	11	8,3	7,9	14	16
#3,0	2,1	11,6	10,2	9	11	8,1	7,2	13	15
	2,8	12,2	11,7	9	11	8,5	8,2	14	16
	3,5	12,5	13,2	10	12	8,7	9,3	15	17
	4,1	12,5	13,2	10	12	8,7	9,3	15	17
#4,0	2,1	11,6	13,2	12	14	8,1	9,3	17	20
	2,8	12,2	15,1	12	14	8,5	10,6	17	20
	3,5	13,1	16,7	12	13	9,2	11,7	17	19
	4,1	13,1	16,7	12	13	9,2	11,7	17	19
#5,0	2,1	13,1	16,7	12	13	9,2	11,7	17	19
	2,8	13,1	18,9	13	15	9,2	13,2	19	22
	3,5	13,4	20,8	14	16	9,4	14,6	20	23
	4,1	13,4	20,8	14	16	9,4	14,6	20	23
#6,0	2,1	12,2	18,9	15	18	8,5	13,2	22	25
	2,8	13,1	22,3	16	18	9,2	15,6	22	26
	3,5	13,1	25,0	17	20	9,2	17,5	25	29
	4,1	13,1	25,0	17	20	9,2	17,5	25	29
#8,0	4,8	13,1	25,0	18	20	9,2	17,5	25	29
	2,1	13,1	25,7	18	21	9,2	18,0	26	30
	2,8	14,3	29,9	17	20	10,0	20,9	25	29
	3,5	14,6	33,3	19	22	10,2	23,3	27	31
#8,0	4,1	14,6	33,3	19	22	10,2	23,3	27	31
	4,8	14,6	33,3	19	22	10,2	23,3	27	31

Low Angle Performance Data – Metric

NOZZLE	NO ADJUSTMENT					-30% ADJUSTMENT			
	PRESSURE	RADIUS	FLOW	PRECIP mm/hr		RADIUS	FLOW	PRECIP mm/hr	
	BAR	METER	L/M	■	▲	METER	L/M	■	▲
#1,0	2,1	7,9	3,4	7	7	6	2,4	9	11
	2,8	8,2	3,8	7	8	6	2,6	10	11
	3,4	8,2	4,5	8	9	6	3,2	11	13
	4,1	7,9	5,3	10	12	6	3,7	14	17
#1,5	2,1	8,5	4,9	8	9	6	3,4	12	13
	2,8	8,8	5,7	9	10	6	4,0	12	14
	3,4	9,1	6,4	9	11	6	4,5	13	15
	4,1	9,4	7,2	10	11	7	5,0	14	16
#2,0	2,1	8,8	7,2	11	13	6	5,0	16	18
	2,8	9,8	8,3	11	12	7	5,8	15	17
	3,4	10,1	9,5	11	13	7	6,6	16	19
	4,1	10,4	10,6	12	14	7	7,4	17	20
#3,0	2,1	9,8	9,5	12	14	7	6,6	17	20
	2,8	10,4	11,4	13	15	7	7,9	18	21
	3,4	10,7	13,3	14	16	7	9,3	20	23
	4,1	11,0	15,1	15	18	8	10,6	22	25

PR Low Angle Performance Data – Metric

NOZZLE	NO ADJUSTMENT					-30% ADJUSTMENT			
	PRESSURE	RADIUS	FLOW	PRECIP mm/hr		RADIUS	FLOW	PRECIP mm/hr	
	BAR	METER	L/M	■	▲	METER	L/M	■	▲
#1,0	2,1	7,9	3,4	7	8	5,5	2,4	9	11
	2,8	8,2	3,8	7	8	5,8	2,6	9	10
	3,5	8,2	4,5	8	9	5,8	3,2	12	13
	4,1	7,9	4,5	9	10	5,5	3,2	14	13
#1,5	2,1	8,5	4,9	8	9	6,0	3,4	12	13
	2,8	8,8	5,7	9	10	6,2	4,0	14	15
	3,5	9,1	6,4	9	11	6,4	4,5	13	15
	4,1	9,1	6,4	9	11	6,4	4,5	13	15
#2,0	2,1	8,8	7,2	11	13	6,2	5,0	16	18
	2,8	9,8	8,3	11	12	6,8	5,8	15	17
	3,5	10,1	9,5	11	13	7,0	6,6	16	19
	4,1	10,1	9,5	11	13	7,0	6,6	16	19
#3,0	2,1	9,8	9,5	12	14	6,8	6,6	17	20
	2,8	10,4	11,4	13	15	7,3	7,9	18	21
	3,5	10,7	13,2	14	16	7,5	9,3	20	23
	4,1	10,7	13,2	14	16	7,5	9,3	20	23

*All precipitation rates calculated for 180° operation. For the precipitation rate for a 360° sprinkler, divide by 2.

RPS™ Select

Four built-in selectable nozzles for the fastest nozzle change of any rotor.

Features

- All adjustments made from the top – wet or dry – including flow shutoff. No special tools needed.
- Four Built-in Selectable Nozzles – Nozzles #1 through #4 match arc settings 90° through 360°
- Matched Precipitation Rates – When nozzle setting matched to arc
- Precision-Engineered Nozzles – Ensures water-saving efficiency
- Standard Rubber Cover
- Proven Water-lubricated Gear-drive Design – Common to the popular RPS™ 75 Series
- Universal Riser Assembly – Fits into existing Hunter® PGP® and PGP® Ultra cans
- Includes 5 Free Check Valve Assemblies Per Box

Specifications

- Arc Adjustment Range: 40° – 360°
- Flow Range: 1.3 – 6.8 GPM (4,9 – 25,8 LPM)
- Operating Pressure Range: 20 – 100 PSI (1,4 – 6,9 bar)
- Recommended Pressure Range: 30 – 50 PSI (2,1 – 3,4 bar)
- Precipitation Rate: 0.21 – 0.69 in/hr (5 – 18 mm/hr) (depending on spacing and nozzle used)
- Radius: 33' – 46' (10 – 14 m)
- Nozzle Trajectory: 24°

Models

- 60003** RPS™ Select Rotor
- 60003-SH** RPS™ Select Rotor, Shrub
- 60003-6INCH** RPS™ Select Rotor 6" (15,2 cm)

Nozzle Selector

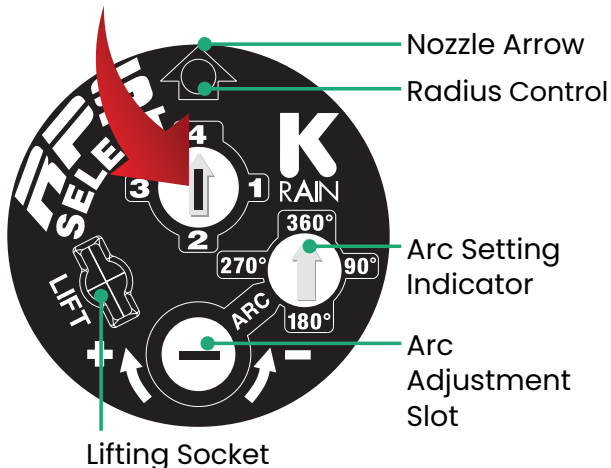

Fast Facts

ALL	INLET: 3/4" (1,9 CM) FEMALE THREAD NPT	
4"	Retracted height:	7 3/8" (19,7 cm)
	Riser height:	4 3/8" (11,1 cm)
6"	Retracted height:	9 1/2" (24,1 cm)
	Riser height:	6 3/8" (16,2 cm)
Shrub	Height:	7 5/8" (16,8 cm)



WATCH VIDEO

Performance Data - U.S.

NOZZLE	PRESSURE	RADIUS	FLOW	PRECIP in/hr	
	PSI	FEET	GPM	■	▲
#1.0	30	33'	1.3	0.23	0.27
	35	34'	1.4	0.23	0.27
	40	37'	1.5	0.21	0.24
	45	37'	1.6	0.22	0.26
	50	37'	1.8	0.25	0.29
#2.0	30	37'	2.6	0.37	0.42
	35	38'	2.8	0.37	0.43
	40	39'	3.0	0.38	0.44
	45	40'	3.2	0.39	0.44
	50	40'	3.6	0.43	0.50
#3.0	30	37'	3.8	0.53	0.62
	35	40'	4.1	0.49	0.57
	40	41'	4.5	0.52	0.60
	45	41'	4.7	0.54	0.62
	50	43'	4.9	0.51	0.59
#4.0	30	38'	5.2	0.69	0.80
	35	40'	5.7	0.69	0.79
	40	44'	6.0	0.60	0.69
	45	45'	6.4	0.61	0.70
	50	46'	6.8	0.62	0.71

Performance Data - Metric

NOZZLE	PRESSURE	RADIUS	FLOW	PRECIP mm/hr	
	BAR	METERS	L/M	■	▲
#1.0	2,1	10,1	4,9	6	7
	2,4	10,4	5,3	6	7
	2,8	10,4	5,7	5	6
	3,1	11,3	6,1	6	7
	3,4	11,3	6,8	6	7
#2.0	2,1	11,3	9,8	9	11
	2,4	11,6	10,6	9	11
	2,8	11,9	11,4	10	11
	3,1	12,2	12,1	10	11
	3,4	12,2	13,6	11	13
#3.0	2,1	11,3	14,4	14	16
	2,4	12,2	15,5	13	14
	2,8	12,2	17,0	13	15
	3,1	12,5	17,8	14	16
	3,4	13,1	18,5	13	15
#4.0	2,1	11,6	19,6	18	20
	2,4	12,2	21,5	17	20
	2,8	13,4	22,7	15	18
	3,1	13,7	24,2	15	18
	3,4	14,0	25,7	16	18

*All precipitation rates calculated for 180° operation.
For the precipitation rate for a 360° sprinkler, divide by 2.

How to Specify with Options

MODELS	OPTIONS
60003	-CV ▶ Check Valve
60003-SH	-RCW ▶ Reclaimed Water Use
60003-6INCH	

Examples: 60003-6INCH-CV, 60003-RCW

Accessories

See page 26-27



Tough, proven and advanced.

Features

- Patented Top Arc Set – Allows for wet or dry adjustment in seconds
- Full arc range adjustment from 40° to continuous 360°
- Patented Arc Set Degree Markings – Clearly indicates current watering pattern & simplifies arc set adjustment
- Arc Memory Clutch – Prevents internal gear damage and returns rotor to its prior setting automatically if nozzle turret is forced past its stop
- Patented Reversing Mechanism – Ensures continuous reverse and return
- Ratcheting Riser – Allows for easy adjustment of the fixed starting position with a simple turn of the riser
- Rubber Cover – Seals out dirt, increases product durability
- Wide Selection of Nozzles – Including standard and low angle, provides flexibility in system design
- Replaces all standard 3/4" rotors
- Includes 5 Free Check Valve Assemblies Per Box

Specifications

- Arc Adjustment Range: 40° to Continuous 360°
- Flow Range: 0.5 – 10.0 GPM (1,9 – 37,8 LPM)
- Operating Pressure Range: 20 – 100 PSI (1,4 – 6,9 bar)
- Recommended Pressure Range: 30 – 70 PSI (2,1 – 4,8 bar)
- Precipitation Rate: 0.12 – 0.88 in/hr (3 – 22 mm/hr) (depending on spacing and nozzle used)
- Radius: 22' – 50' (6,7 – 15,2 m)
- Nozzle Trajectory: 26°
- Low Angle Nozzle Trajectory: 12°
- Standard and Low Angle Nozzles Included

Model

11003 ProPlus®

Accessories

See page 26–27

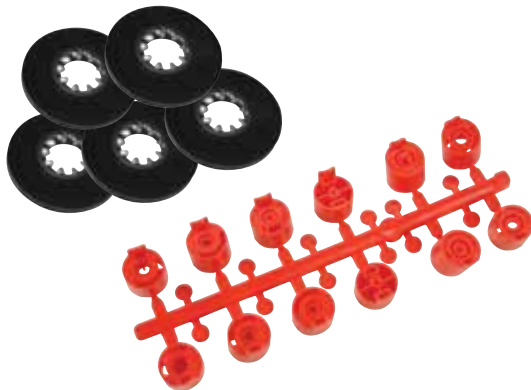

Fast Facts

ALL	INLET: 3/4" (1,9 CM) FEMALE THREAD NPT	
4"	Retracted height:	7 1/2" (19 cm)
	Riser height:	4 1/4" (10,8 cm)

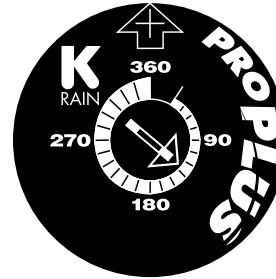

Easy Arc Setting

Arc Selection: 40° to continuous 360°
Adjust from left start



How to Specify with Options

MODELS	OPTIONS	
11003	-CV	▶ Check Valve
	-LA	▶ Low angle Nozzle
	-NN	▶ No Nozzle
	-RCW	▶ Reclaimed Water

Examples: 11003-RCW-CV

Performance Data - U.S.

NOZZLE	NO ADJUSTMENT				
	PRESSURE	RADIUS	FLOW	PRECIP in/hr	
	PSI	FEET	GPM	■	▲
#0.5	30	28	0.5	0.12	0.14
	40	29	0.6	0.14	0.16
	50	29	0.7	0.16	0.19
	60	30	0.8	0.17	0.20
#0.75	30	29	0.7	0.16	0.19
	40	30	0.8	0.17	0.20
	50	31	0.9	0.18	0.21
	60	32	1.0	0.19	0.22
#1.0	30	32	1.3	0.24	0.28
	40	33	1.5	0.27	0.31
	50	34	1.6	0.27	0.31
	60	35	1.8	0.28	0.33
#2.0	30	37	2.4	0.34	0.39
	40	40	2.5	0.30	0.35
	50	42	3.0	0.33	0.38
	60	43	3.3	0.34	0.40
#2.5 Pre- Installed	30	38	2.5	0.33	0.38
	40	39	2.8	0.35	0.41
	50	40	3.2	0.39	0.44
	60	41	3.5	0.40	0.46
#3.0	30	38	3.6	0.48	0.55
	40	39	4.2	0.53	0.61
	50	41	4.6	0.53	0.61
	60	42	5.0	0.55	0.63
#4.0	30	43	4.4	0.46	0.53
	40	44	5.1	0.51	0.59
	50	46	5.6	0.51	0.59
	60	49	5.9	0.47	0.55
#6.0	40	45	5.9	0.56	0.65
	50	46	6.0	0.55	0.63
	60	48	6.3	0.53	0.61
	70	49	6.7	0.54	0.62
#8.0	40	42	8	0.87	1.01
	50	45	8.5	0.81	0.93
	60	49	9.5	0.76	0.88
	70	50	10	0.77	0.89

Performance Data - Metric

NOZZLE	NO ADJUSTMENT				
	PRESSURE	RADIUS	FLOW	PRECIP mm/hr	
	BAR	METER	L/M	■	▲
#0.5	2,1	8,5	1,9	3	4
	2,8	8,8	2,3	3	4
	3,4	8,8	2,6	4	5
	4,1	9,1	3,0	4	5
#0.75	2,1	8,8	2,6	4	5
	2,8	9,1	3,0	4	5
	3,4	9,4	3,4	5	5
	4,1	9,8	3,8	5	6
#1.0	2,1	9,8	4,9	6	7
	2,8	10,1	5,7	7	8
	3,4	10,4	6,1	7	8
	4,1	10,7	6,8	7	8
#2.0	2,1	11,3	9,1	9	10
	2,8	12,2	9,5	8	9
	3,4	12,8	11,4	8	10
	4,1	13,1	12,5	9	10
#2.5 Pre- Installed	2,1	11,6	9,5	8	10
	2,8	11,9	10,6	9	10
	3,4	12,2	12,1	10	11
	4,1	12,5	13,2	10	12
#3.0	2,1	11,6	13,6	12	14
	2,8	11,9	15,9	14	16
	3,4	12,5	17,4	13	15
	4,1	12,8	18,9	14	16
#4.0	2,1	13,1	16,7	12	13
	2,8	13,4	19,3	13	15
	3,4	14,0	21,2	13	15
	4,1	14,9	22,3	12	14
#6.0	2,8	13,7	22,3	14	16
	3,4	14,0	22,7	14	16
	4,1	14,6	23,8	13	15
	4,8	14,9	25,4	14	16
#8.0	2,8	12,8	30,3	22	26
	3,4	13,7	32,2	21	24
	4,1	14,9	36,0	19	22
	4,8	15,2	37,9	20	23

Low Angle Performance Data - U.S.

NOZZLE	NO ADJUSTMENT				
	PRESSURE	RADIUS	FLOW	PRECIP in/hr	
	PSI	FEET	GPM	■	▲
#1.0	30	22	1.2	0.48	0.55
	40	24	1.7	0.57	0.66
	50	26	1.8	0.51	0.59
	60	28	2.0	0.49	0.57
#3.0	30	29	3.0	0.69	0.79
	40	32	3.1	0.58	0.67
	50	35	3.5	0.55	0.64
	60	37	3.8	0.53	0.62
#4.0	30	31	3.4	0.68	0.79
	40	34	3.9	0.65	0.75
	50	37	4.4	0.62	0.71
	60	38	4.7	0.63	0.72
#6.0	40	38	6.5	0.87	1.00
	50	40	7.3	0.88	1.01
	60	42	8.0	0.87	1.01
	70	44	8.6	0.86	0.99

Low Angle Performance Data - Metric

NOZZLE	NO ADJUSTMENT				
	PRESSURE	RADIUS	FLOW	PRECIP mm/hr	
	PSI	FEET	GPM	■	▲
#1.0	2,1	6,7	4,5	12	14
	2,8	7,3	6,4	14	17
	3,4	7,9	6,8	13	15
	4,1	8,5	7,6	12	14
#3.0	2,1	8,8	11,4	17	20
	2,8	9,8	11,7	15	17
	3,4	10,7	13,2	14	16
	4,1	11,3	14,4	14	16
#4.0	2,1	9,4	12,9	17	20
	2,8	10,4	14,8	17	19
	3,4	11,3	16,7	16	18
	4,1	11,6	17,8	16	18
#6.0	2,8	11,6	24,6	22	25
	3,4	12,2	27,6	22	26
	4,1	12,8	30,3	22	26
	4,8	13,4	32,6	22	25

*All precipitation rates calculated for 180° operation. For the precipitation rate for a 360° sprinkler, divide by 2.



SuperPro®

All the best features in one rotor including Intelligent Flow Technology®.

Features

- Patented Intelligent Flow Technology® – Reduce distance and water flow simultaneously and proportionately
- Patented easy arc set – Simplified setting wet or dry. Water flow can be turned off or adjusted in the popped-up position.
- Adjustable or continuous rotation – Provides a full range of adjustment from 40° to continuous 360°
- Patented arc set degree markings – Clearly indicates current watering pattern, simplifies arc set adjustment
- Arc memory clutch – Prevents internal gear damage and returns rotor to its prior setting automatically if nozzle turret is forced out of adjustment
- Patented reversing mechanism – Ensures continuous reverse and return
- Ratcheting riser – Allows for easy adjustment of your left starting position with a simple turn of the riser
- Rubber cover – Seals out dirt and increases durability
- Includes 5 Free Check Valve Assemblies Per Box
- Rugged stainless steel spring – 302 stainless steel spring extends the life of the rotor

Specifications

- Arc adjustment range: 40° to continuous 360°
- Flow range: 0.8 – 11.1 GPM (3,0 – 42,0 LPM)
- Operating Pressure Range: 20 – 100 PSI (1,4 – 6,9 bar)
- Recommended Pressure Range: 30 – 70 PSI (2,1 – 4,8 bar)
- Precipitation rate: 0.21 – 1.50 in/hr (5 – 38 mm/hr) (depending on spacing and nozzle used)
- Radius: 26' – 46' (7,9 – 14,0 m)
- Nozzle trajectory: 26°
- Low angle nozzle trajectory: 11°
- Standard and low angle nozzles included

Models

- 10003** SuperPro
- 10003-HP** SuperPro High Pop

Accessories

See page 26–27

Fast Facts

ALL	INLET: 3/4" (1,9 CM) FEMALE THREAD NPT	
Standard	Retracted height:	7 1/2" (19,0 cm)
	Riser height:	4 3/4" (12,1 cm)
High pop	Retracted height:	17 (43,2 cm)
	Riser height:	11 1/2" (29,2 cm)
Shrub	Height:	7 3/4" (19,7 cm)



Performance Data - U.S.

NOZZLE	NO ADJUSTMENT					-30% ADJUSTMENT			
	PRESSURE	RADIUS	FLOW	PRECIP in/hr		RADIUS	FLOW	PRECIP in/hr	
	PSI	FEET	GPM	■	▲	FEET	GPM	■	▲
#1.0	30	29	0.9	0.21	0.24	20	0.6	0.29	0.34
	40	29	1.0	0.23	0.26	20	0.7	0.33	0.38
	50	30	1.1	0.24	0.27	21	0.8	0.34	0.39
	60	32	1.2	0.23	0.26	22	0.8	0.32	0.37
#1.5	30	33	1.3	0.23	0.27	23	0.9	0.33	0.38
	40	35	1.5	0.24	0.27	25	1.1	0.34	0.39
	50	37	1.7	0.24	0.28	26	1.2	0.34	0.39
	60	38	1.9	0.25	0.29	27	1.3	0.36	0.42
#2.0	30	33	1.4	0.25	0.29	23	1.0	0.35	0.41
	40	36	1.7	0.25	0.29	25	1.2	0.36	0.42
	50	37	2.0	0.28	0.32	26	1.4	0.40	0.46
	60	37	2.3	0.32	0.37	26	1.6	0.46	0.53
#2.5 Pre- Installed	30	35	1.9	0.30	0.34	25	1.3	0.43	0.49
	40	36	2.2	0.33	0.38	25	1.5	0.47	0.54
	50	37	2.6	0.37	0.42	26	1.8	0.52	0.60
	60	38	2.9	0.39	0.45	27	2.0	0.55	0.64
#3.0	30	33	2.3	0.41	0.47	23	1.6	0.58	0.67
	40	34	2.7	0.45	0.52	24	1.9	0.64	0.74
	50	36	3.1	0.46	0.53	25	2.2	0.66	0.76
	60	38	3.4	0.45	0.52	27	2.4	0.65	0.75
#4.0	30	33	3.1	0.55	0.63	23	2.2	0.78	0.90
	40	34	3.7	0.62	0.71	24	2.6	0.88	1.02
	50	38	4.2	0.56	0.65	27	2.9	0.80	0.92
	60	39	4.6	0.58	0.67	27	3.2	0.83	0.96
#5.0	30	35	3.8	0.60	0.69	25	2.7	0.85	0.99
	40	37	4.6	0.65	0.75	26	3.2	0.92	1.07
	50	40	5.3	0.64	0.74	28	3.7	0.91	1.05
	60	42	5.8	0.63	0.73	29	4.1	0.90	1.04
#6.0	30	35	4.5	0.71	0.82	25	3.2	1.01	1.17
	40	40	5.3	0.64	0.74	28	3.7	0.91	1.05
	50	41	6.0	0.69	0.79	29	4.2	0.98	1.13
	60	42	6.7	0.73	0.84	29	4.7	1.04	1.21
	70	44	7.4	0.74	0.85	31	5.2	1.05	1.21
#8.0	30	35	5.9	0.93	1.07	25	4.1	1.32	1.53
	40	40	7.0	0.84	0.97	28	4.9	1.20	1.39
	50	42	8.0	0.87	1.01	29	5.6	1.25	1.44
	60	45	8.8	0.84	0.97	32	6.2	1.20	1.38
	70	45	9.6	0.91	1.05	32	6.7	1.30	1.51

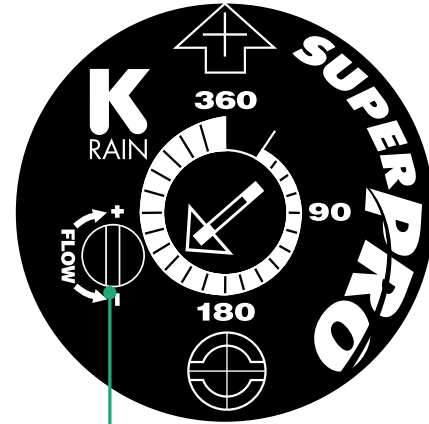

- Reduces distance and flow rate simultaneously and proportionately
- Provides full on/off control

Low Angle Performance Data - U.S.

NOZZLE	NO ADJUSTMENT					-30% ADJUSTMENT			
	PRESSURE	RADIUS	FLOW	PRECIP in/hr		RADIUS	FLOW	PRECIP in/hr	
	PSI	FEET	GPM	■	▲	FEET	GPM	■	▲
#1.0	30	25	0.9	0.28	0.32	18	0.6	0.40	0.46
	40	26	1.0	0.28	0.33	18	0.7	0.41	0.47
	50	27	1.1	0.29	0.34	19	0.8	0.41	0.48
	60	28	1.2	0.29	0.34	20	0.8	0.42	0.49
#1.5	30	27	1.0	0.26	0.30	19	0.7	0.38	0.44
	40	29	1.2	0.27	0.32	20	0.8	0.39	0.45
	50	27	1.3	0.34	0.40	19	0.9	0.49	0.57
	60	28	1.5	0.37	0.43	20	1.1	0.53	0.61
#2.0	30	29	1.6	0.37	0.42	20	1.1	0.52	0.60
	40	32	1.9	0.36	0.41	22	1.3	0.51	0.59
	50	33	2.1	0.37	0.43	23	1.5	0.53	0.61
	60	33	2.4	0.42	0.49	23	1.7	0.61	0.70
#3	30	29	2.2	0.50	0.58	20	1.5	0.72	0.83
	40	33	2.7	0.48	0.55	23	1.9	0.68	0.79
	50	34	3.0	0.50	0.58	24	2.1	0.71	0.82
	60	36	3.3	0.49	0.57	25	2.3	0.70	0.81

*All precipitation rates calculated for 180° operation.
For the precipitation rate for a 360° sprinkler, divide

How to Specify with Options

MODELS	OPTIONS
10003	-CV ▶ Check Valve
10003-HP	-NN ▶ No Nozzle
10003-SH	-RCW ▶ Reclaimed Water Use
	-OS ▶ On-site Wastewater

Examples: 10003-RCW-CV



WATCH VIDEO

Performance Data - Metric

NOZZLE	NO ADJUSTMENT					-30% ADJUSTMENT			
	PRESSURE	RADIUS	FLOW	PRECIP mm/hr		RADIUS	FLOW	PRECIP mm/hr	
	BAR	METER	L/M	■	▲	METER	L/M	■	▲
#1,0	2,1	8,8	3,4	5	6	6,2	2,4	7	9
	2,8	8,8	3,8	6	7	6,2	2,6	8	10
	3,4	9,1	4,2	6	7	6,4	2,9	9	10
	4,1	9,8	4,5	6	7	6,9	3,2	8	9
#1,5	2,1	10,1	4,9	6	7	7,1	3,4	8	10
	2,8	10,7	5,7	6	7	7,5	4,0	9	10
	3,4	11,3	6,4	6	7	7,9	4,5	9	10
	4,1	11,6	7,2	6	7	8,1	5,0	9	11
#2,0	2,1	10,1	5,3	6	7	7,1	3,7	9	10
	2,8	11,0	6,4	6	7	7,7	4,5	9	11
	3,4	11,3	7,6	7	8	7,9	5,3	10	12
	4,1	11,3	8,7	8	9	7,9	6,1	12	14
#2,5 Pre- Installed	2,1	10,7	7,2	8	9	7,5	5,0	11	13
	2,8	11,0	8,3	8	10	7,7	5,8	12	14
	3,4	11,3	9,8	9	11	7,9	6,9	13	15
	4,1	11,6	11,0	10	11	8,1	7,7	14	16
#3,0	2,1	10,6	8,7	10	12	7,4	6,1	15	17
	2,8	10,4	10,2	11	13	7,3	7,2	16	19
	3,4	11,0	11,7	12	14	7,7	8,2	17	19
	4,1	11,6	12,9	12	13	8,1	9,0	16	19
#4,0	2,1	10,1	11,7	14	16	7,0	8,2	20	23
	2,8	10,4	14,0	16	18	7,3	9,8	22	26
	3,4	11,6	15,9	14	16	8,1	11,1	20	23
	4,1	11,9	17,4	15	17	8,3	12,2	21	24
#5,0	2,1	10,7	14,4	15	18	7,5	10,1	22	28
	2,8	11,3	17,4	16	19	7,9	12,2	23	27
	3,4	12,2	20,1	16	19	8,5	14,0	23	27
	4,1	12,8	22,0	16	19	9,0	15,4	23	27
#6,0	2,1	10,7	17,0	18	21	7,5	11,9	26	30
	2,8	12,2	20,1	16	19	8,5	14,0	23	27
	3,4	12,5	22,7	17	20	8,7	15,9	25	29
	4,1	12,8	25,4	19	21	9,0	17,8	27	31
	4,8	13,4	28,0	19	22	9,8	19,6	27	31
#8,0	2,1	10,7	22,3	24	27	7,5	15,6	34	39
	2,8	12,2	26,5	21	25	8,5	18,5	31	35
	3,4	12,8	30,3	22	26	9,0	21,2	32	37
	4,1	13,7	33,3	21	25	9,6	23,3	30	35
	4,8	13,7	36,3	23	27	10,7	25,4	33	38

PR Low Angle Performance Data - Metric

NOZZLE	NO ADJUSTMENT					-30% ADJUSTMENT			
	PRESSURE	RADIUS	FLOW	PRECIP mm/hr		RADIUS	FLOW	PRECIP mm/hr	
	BAR	METER	L/M	■	▲	METER	L/M	■	▲
#1,0	2,1	7,6	3,4	7	8	5,3	2,4	10	12
	2,8	7,9	3,8	7	8	5,5	2,6	10	12
	3,4	8,2	4,2	7	9	5,8	2,9	11	12
	4,1	8,5	4,5	7	9	6,0	3,2	11	12
#1,5	2,1	8,2	3,8	7	8	5,8	2,6	10	11
	2,8	8,8	4,5	7	8	6,2	3,2	10	12
	3,4	8,2	4,9	9	10	5,8	3,4	12	14
	4,1	8,5	5,7	9	11	6,0	4,0	13	15
#2,0	2,1	8,8	6,1	9	11	6,2	4,2	13	15
	2,8	9,8	7,2	9	10	6,8	5,0	13	15
	3,4	10,1	7,9	9	11	7,0	5,6	13	16
	4,1	10,1	9,1	11	12	7,0	6,4	15	18
#3,0	2,1	8,8	8,3	13	15	6,2	5,8	18	21
	2,8	10,1	10,2	12	14	7,0	7,2	17	20
	3,4	10,4	11,4	13	15	7,3	7,9	18	21
	4,1	11,0	12,5	12	14	7,7	8,7	18	21

*All precipitation rates calculated for 180° operation.
For the precipitation rate for a 360° sprinkler, divide by 2.





Designed for sports turf and commercial applications.

Features

- Patented Top Arc Set – Allows for adjustment in seconds
- Triple Nozzle Configuration – Ensures even distribution of water
- Arc adjustment from 40° to a continuous 360°
- Top Arc Set Degree Markings – Clearly indicates the current watering pattern and simplifies arc set adjustment
- Arc Memory Clutch – Prevents internal gear damage and returns rotor to its prior setting automatically if nozzle turret is forced past stop
- Patented Reversing Mechanism – Continuous reverse and return
- Heavy Duty Rubber Cover and Mud Guard – Protects against physical injury and allows sprinkler to be installed below grade
- Factory Installed Check Valve – Prevents low head drainage

Specifications

- Arc Adjustment Range: 40° to Continuous 360°
- Flow Range: 5.1 – 32.5 GPM (19,3 – 123 LPM)
- Operating Pressure Range: 40 – 100 PSI (2,8 – 6,9 bar)
- Recommended Pressure Range: 40 – 90 PSI (2,8 – 6,2 bar)
- Precipitation Rate: 0.48 – 1.35 in/hr (12,2 – 34 mm/hr) (depending on spacing and nozzle used)
- Radius: 43' – 77' (13,1 – 23,5 m)
- Nozzle Trajectory: 26°

Model

- 14003** ProSport® Plastic
- 14003-6INCH** ProSport® Plastic 6 inch
- 14003-TC-6INCH** 6 inch, NPT, Turf Cup, ProSport®
- 14003-BSP-TC-6INCH** 6 inch, BSP, Turf Cup, ProSport®
- 14053** ProSport® High Speed Plastic
- 14053-6INCH** ProSport® High Speed Plastic 6 inch
- 14053-TC-6INCH** 6 inch, NPT, Turf Cup, ProSport® Hi-Speed
- 14053-BSP-TC-6INCH** 6 inch, BSP, Turf Cup, ProSport® Hi-Speed

Fast Facts

ALL	INLET: 1" (2,5 CM) FEMALE THREAD NPT OR BSP
4"	Retracted height: 7 1/2" (19 cm) Riser height: 4 1/2" (11,4 cm)
6"	Retracted height: 12" (30,5 cm) Riser height: 6 1/4" (15,9 cm)
6" Turf Cup	Retracted height: 15" (38,1 cm) Riser height: 6 1/4" (15,9 cm)







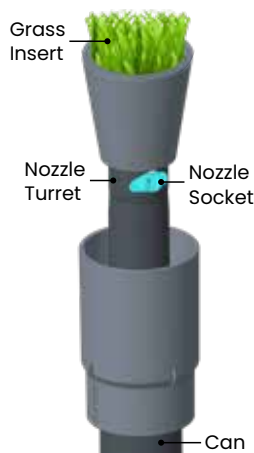

PROSPORT WITH TURF Cup









6" Model Only









14003 Performance Data - U.S.

NOZZLE	NO ADJUSTMENT				
	PRESSURE	RADIUS	FLOW	PRECIP in/hr	
	PSI	FEET	GPM	■	▲
	40	43	5.5	0.57	0.66
	50	44	6.0	0.60	0.69
	60	45	7.0	0.67	0.77
	70	46	8.0	0.73	0.84
	50	49	11.8	0.95	1.09
	60	52	12.8	0.91	1.05
	70	53	13.8	0.95	1.09
	80	54	14.5	0.96	1.11
	50	52	14.0	1.00	1.15
	60	54	16.0	1.06	1.22
	70	56	17.0	1.04	1.20
	80	58	18.0	1.03	1.19
	60	56	19.8	1.22	1.40
	70	58	21.0	1.20	1.39
	80	59	21.5	1.19	1.37
	90	60	22.0	1.18	1.36
	60	62	23.5	1.18	1.36
	70	66	26.5	1.17	1.35
	80	67	28.0	1.20	1.39
	90	68	29.0	1.21	1.39
	60	65	25.0	1.14	1.32
	70	72	30.0	1.11	1.29
	80	73	31.5	1.14	1.31
	90	75	33.5	1.15	1.32







14003 Performance Data - Metric

NOZZLE	NO ADJUSTMENT				
	PRESSURE	RADIUS	FLOW	PRECIP mm/hr	
	BAR	METER	L/M	■	▲
	2,8	13,1	20,8	15	17
	3,5	13,4	22,7	15	17
	4,1	13,7	26,5	17	20
	4,8	14,0	30,3	18	21
	3,5	14,9	44,7	24	28
	4,1	15,8	48,5	23	27
	4,8	16,2	52,2	24	28
	5,5	16,5	54,9	24	28
	3,5	15,8	53,0	25	29
	4,1	16,5	60,6	27	31
	4,8	17,1	64,4	27	31
	5,5	17,7	68,1	26	30
	4,1	17,1	75,0	31	36
	4,8	17,7	79,5	31	35
	5,5	18,0	81,4	30	35
	6,2	18,3	83,3	30	35
	4,1	18,9	89,0	30	35
	4,8	20,1	100,3	30	34
	5,5	20,4	106,0	30	35
	6,2	20,7	109,8	31	35
	4,1	19,8	94,6	29	33
	4,8	21,9	113,6	28	33
	6,2	22,2	119,2	29	33
	6,2	22,9	126,8	29	34

14053 Performance Data - U.S.

NOZZLE	NO ADJUSTMENT				
	PRESSURE	RADIUS	FLOW	PRECIP in/hr	
	PSI	FEET	GPM	■	▲
	40	43	5.5	0.61	0.71
	50	44	6.0	0.62	0.71
	60	45	7.0	0.61	0.70
	70	45	8.0	0.72	0.83
	50	49	11.8	0.85	0.98
	60	53	12.8	0.79	0.91
	70	53	13.8	0.91	1.05
	80	54	14.5	0.92	1.07
	50	52	14.0	0.88	1.02
	60	54	16.0	0.90	1.04
	70	56	17.0	0.90	1.03
	80	58	18.0	0.91	1.05
	60	56	19.8	1.22	1.40
	70	58	21.0	1.21	1.40
	80	59	21.5	1.26	1.46
	90	60	22.0	1.30	1.51
	60	59	23.5	1.24	1.43
	70	66	26.5	1.14	1.31
	80	67	28.0	1.19	1.38
	90	68	29.0	1.24	1.44
	60	60	25.0	1.35	1.56
	70	72	30.0	1.06	1.22
	80	73	31.5	1.11	1.28
	90	75	33.5	1.11	1.28

14053 Performance Data - Metric

NOZZLE	NO ADJUSTMENT				
	PRESSURE	RADIUS	FLOW	PRECIP mm/hr	
	BAR	METER	L/M	■	▲
	2,8	13,1	20,8	15	18
	3,5	13,4	22,7	16	18
	4,1	13,7	26,5	15	18
	4,8	13,7	30,3	18	21
	3,5	14,9	44,7	22	25
	4,1	15,8	48,5	20	23
	4,8	16,1	52,2	23	27
	5,5	16,5	54,9	23	27
	3,5	15,8	53,0	22	26
	4,1	16,5	60,6	23	26
	4,8	17,1	64,4	23	26
	5,5	17,1	68,1	23	27
	4,1	17,1	75,0	31	36
	4,8	17,7	79,5	31	36
	5,5	18,0	81,4	32	37
	6,2	18,3	83,3	33	38
	4,1	18,0	89,0	31	36
	4,8	20,1	100,3	29	33
	5,5	20,4	106,0	30	35
	6,2	20,7	109,8	31	37
	4,1	18,3	94,6	34	40
	4,8	22,0	113,6	27	31
	6,2	22,2	119,2	28	33
	6,2	22,9	126,8	28	33

*All precipitation rates calculated for 180° operation. For the precipitation rate for a 360° sprinkler, divide by 2.

How to Specify with Options

MODELS	OPTIONS
14003	-SS ▶ Stainless Steel (4" only)
14003-6INCH	-BSP ▶ with BSP Thread
14053	-RCW ▶ Reclaimed Water Use

Examples: 14003-BSP, 14053-RCW-NN

Easy Arc Setting

Arc Selection: 40° to continuous 360°
Adjust from left start



WATCH VIDEO



Visit our Sport Field Designs.

Accessories

See page 26-27

Rotor Accessories

Nozzle Racks

P52775 MiniPro® and RPS™ 50 Nozzle Rack (red)

P51399 ProPlus® Nozzle Rack (red)
Standard: 0.5, 0.75, 1, 2, 3, 4, 6, 8 GPM
Low Angle: 1, 3, 4, 6 GPM
Pre-installed Nozzle: 2.5 GPM

P16001101 RPS™ 75 Nozzle Rack (red)
Standard: 0.75, 1, 1.5, 2, 4, 6, 8 GPM
Low Angle: 1, 3, 4, 6 GPM
Pre-installed Nozzle: 3.0 GPM

P90001102 ProPlus-RCW low angle nozzle rack

P16001110 RPS™ 75i, SuperPro Nozzle Rack (green)
Standard: 1, 1.5, 2, 2.5, 3, 4, 5, 6, 8 GPM
Low Angle: 1, 1.5, 2, 3 GPM
Pre-installed Nozzle: 2.5 GPM

ProSport®

P14055130 Complete set of Nozzles (1 nozzle of each)

P55519-5 5 GPM (18,9 LPM), white (12 count)
P55519-10 10 GPM (37,9 LPM), green (12 count)
P55519-15 15 GPM (56,8 LPM), gray (12 count)
P55519-20 20 GPM (75,7 LPM), brown (12 count)
P55519-25 25 GPM (94,6 LPM), blue (12 count)
P55519-30 30 GPM (113,5 LPM), black (12 count)

Adjustment Tools

P59995 K-Key; MiniPro®, ProPlus® Adjustment Key

P1000902 SuperPro®, RPS™ Select, ProSport® Adjustment Key

P1000901 RPS™ 75, RPS™ 75i, RPS™ 50 Adjustment Key

P52775



P51399

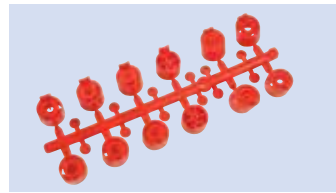

P16001101

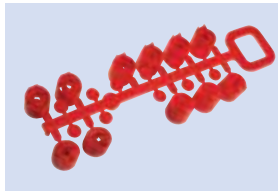

P16001110

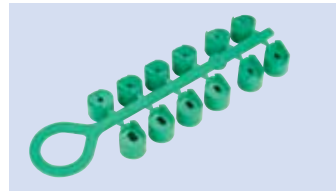

P90001102



P55519

5 GPM



10 GPM



15 GPM



20 GPM



25 GPM



30 GPM



P59995



P1000901

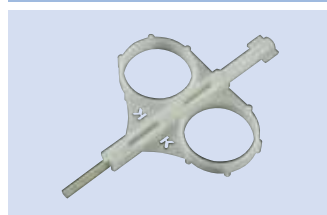

P1000902



Riser Clips, Check Valves and Filter Baskets

- P54065** Riser Clip
- P51210** SuperPro®-HP, SuperPro®-SH, RPS™ Select-SH, RPS™ 75-SH, RPS™ 75i-SH, ProPlus® High Pop and ProPlus® Shrub Check Valve
- P513995** MiniPro®, RPS™ 50 Check Valve
- P16009110** RPS™ 75, 75i, Select, ProPlus®, SuperPro® Check Valve Assembly
- P53425** ProSport® Check Valve
- P51114** MiniPro® Filter Basket
- P51115** RPS™ 75, 75i, Select Filter Basket
- P51112** SuperPro® High Pop, ProPlus® High Pop Filter Basket, SuperPro®-SH, RPS™ Select-SH, RPS™ 75-SH, RPS™ 75i-SH, Shrub Check Valve
- P58115** ProPlus®, SuperPro® Filter Basket

Swing Pipe & Fittings

- KA05100** Swing Pipe, 1/2" x 100' Roll
- SWPC050** Swing Pipe, Coupling, 1/2" Barb
- SWPT050** Swing Pipe, Tee, 1/2" Barb
- SWPE050** Swing Pipe, Elbow, 1/2" MNPT x 1/2" Barb
- SWPE075** Swing Pipe, Elbow, 3/4" MNPT x 1/2" Barb
- SWPA060505** Swing Pipe Assembly, 6in, 1/2" Inlet x 1/2" Outlet
- SWPA060575** Swing Pipe Assembly, 6in, 1/2" Inlet x 3/4"
- SWPA067575** Swing Pipe Assembly, 6in, 3/4" Inlet x 3/4" Outlet
- SWPA120505** Swing Pipe Assembly, 12in, 1/2" Inlet x 1/2" Outlet
- SWPA120575** Swing Pipe Assembly, 12in, 1/2" Inlet x 3/4" Outlet
- SWPA127575** Swing Pipe Assembly, 12in, 3/4" Inlet x 3/4" Outlet
- SWPA180505** Swing Pipe Assembly, 18in, 1/2" Inlet x 1/2" Outlet
- SWPA187575** Swing Pipe Assembly, 18in, 3/4" Inlet x 3/4" Outlet



SPRAYS



Spray Body | Comparison Chart

The perfect combination of precise engineering and extensive field testing ensures long life and outstanding performance with every K-Rain® spray. Well-suited for any application, the sprays are rugged, reliable and available in a wide selection of sizes for optimal flexibility.

	Pro-S™ Sprays					NP Sprays		K-Sprays			
	78002	78003	78004	78006	78012	NP2	NP4	73001	74001	76001	71201
Specifications											
Pop-up height	11/2"	2 1/2"	3 1/2"	5 1/2"	11 1/2"	2"	3 7/8"	2 1/2"	4"	5 7/8"	11 1/2"
Retracted height	4 3/8"	5"	6"	9 3/8"	16"	4"	6"	4 3/4"	5 7/8"	8"	15 3/4"
Operating Pressure Range: (PSI)	20-110	20-110	20-110	20-110	20-110	20-70	20-70	20-70	20-70	20-70	20-70
Inlet	1/2" female thread	1/2" female thread	1/2" female thread	1/2" female thread	1/2" female thread	1/2" female thread	1/2" female thread	1/2" female thread	1/2" female thread	1/2" female thread	1/2" female thread
Nozzle	female thread	female thread	female thread	female thread	female thread	female thread	female thread	male thread	male thread	male thread	male thread
Features											
Co-molded wiper seal	●	●	●	●	●						
Ratcheting riser	●	●	●	●	●	●	●	●	●	●	●
Heavy duty retraction spring	●	●	●	●	●	●	●	●	●	●	●
Side inlet				●	●						●
Narrow profile						●	●				
Warranty	7 years	7 years	7 years	7 years	7 years	7 years	7 years	7 years	7 years	7 years	7 years
Options											
Check valve	●	●	●	●	●	●	●	●	●	●	●
Nozzle guard	●	●	●	●	●						
Pressure regulator 30 PSI			●	●	●						
Pressure regulator 40 PSI			●	●	●						
Reclaimed water use	●	●	●	●	●			●	●	●	●
Stop Flow™			●	●							
Customizable	●	●	●	●	●						

Pro-S™ Sprays

Proven long life and outstanding performance.

Features

- Co-molded wiper seal – Ensures a leak-free, full pop-up even under low pressure situations. Treated with UV inhibitors for long life. Carefully selected seal material reduces degradation and stick-ups
- Ratcheting Riser – Allows for easy pattern alignment by turning the riser
- Heavy-duty retraction spring – Strongest in the industry for complete retraction in all soil conditions
- Pre-installed flush cap
- Accepts female threaded nozzles
- Riser assembly fits into 1800 body

Specifications

- Operating Pressure Range: 20 – 110 PSI (1,4 – 7,6 bar)
- Flow-by: 0 – 8 PSI (0,6 bar) 0.20 GPM (0,76 LPM)
- Inlet: 1/2" (1,3 cm) Female Thread NPT

Models

- 78002** Pro-S 2" (5 cm) Pop-up
- 78003** Pro-S 3" (7,5 cm) Pop-up
- 78004** Pro-S 4" (10 cm) Pop-up
- 78006** Pro-S 6" (15 cm) Pop-up w/optional side inlet
- 78012** Pro-S 12" (30 cm) Pop-up w/side inlet

Accessories

See page 34

Fast Facts

ALL	INLET: 1/2" (1,3 CM) FEMALE THREAD NPT
2"	Retracted height: 4 3/8" (11,1 cm) Riser height: 1 1/2" (3,8 cm)
3"	Retracted height: 5" (12,7 cm) Riser height: 2 1/2" (6,4 cm)
4"	Retracted height: 6" (15,2) Riser height: 3 1/2" (8,9 cm)
6"	Retracted height: 9 3/8" (23,8 cm) Riser height: 5 1/2" (14,0 cm)
12"	Retracted height: 16" (40,6 cm) Riser height: 11 1/2" (29,2 cm)



Options

In-stem Pressure Regulator

- Factory preset at 30 or 40 PSI (2,1 or 2,8 bar)
- Available in 4", 6", and 12". EPA WaterSense certified
- Visit krain.com/watersense-certified for a full list



In-stem Check Valve

- Pre-installed or installs in the field
- Holds up to 10' (3 m) of head pressure



Pre-installed Nozzle Guard

- Protects the nozzle from foot traffic, mowers, edgers, and arc changes



Stop Flow™

- Automatically stops water flow should the nozzle become damaged or removed 4" and 6" only

Stop Flow™ valve



How to Specify with Options

MODELS	OPTIONS	
78002	-CV	▶ Check Valve
78003	-GUARD	▶ Nozzle Guard
78004	-NSI	▶ No Side Inlet (6" only)
78006	-PR30	▶ Pressure Regulator 30 PSI (4", 6" 12" only)
78012	-PR40	▶ Pressure Regulator 40 PSI (4", 6" 12" only)
	-RCW	▶ Reclaimed Water Use
	-SF	▶ Stop Flow™ 4", 6" and 12" Only

Examples: 78004-CV, 78006-NSI-RCW, 78012-CV-PR30



Pro-S Spray



Pro-S Spray with Stop Flow



NP Sprays

Ideal for watering smaller lawns, ground cover, and shrub areas.

Features

- Available in 2" and 4" (5 cm and 10 cm) Models – Provides flexibility in system design
- Accepts Female Threaded Nozzles
- Stainless Steel Retraction Spring – Provides reliable retraction of the riser in all soil conditions
- Ratcheting Riser – Allows for easy pattern alignment by turning the riser
- Narrow Profile Body – Easy to retrofit with existing systems

Specifications

- Operating Pressure Range: 20 – 70 PSI (1,4 – 4,8 bar)
- Inlet: 1/2" (1,3 cm) female thread NPT

Models

- NP2** 2" (5 cm) Narrow Profile Spray Body
- NP4** 4" (10 cm) Narrow Profile Spray Body



Fast Facts

ALL	INLET: 1/2" (1,3 CM) FEMALE THREAD NPT	
NP2	Retracted height:	4" (10,2 cm)
	Riser height:	2" (5,1 cm)
NP4	Retracted height:	6" (15,2 cm)
	Riser height:	3 7/8" (9,8 cm)

How to Specify

MODELS	OPTIONS
NP2	-CV ▶ Check Valve
NP4	

Examples: NP4-CV

Accessories

See page 34



For small flower beds to residential and light commercial lawns.

Features

- Available in 3", 4", 6" and 12" Models – Provides flexibility in system design
- Accepts Male Threaded Nozzles
- Stainless Steel Retraction Spring – Provides reliable retraction of the riser in all soil conditions
- Ratcheting Riser – Allows for easy pattern alignment by turning the riser
- Heavy Duty Wiper Seal – Ensures leak free, full pop-up operation even under low-pressure situations
- Optional Water-Saving Check Valve – Eliminates low head drainage
- Optional Purple Cap for Reclaimed Water Use – Highly visible for identification of RCW systems

Specifications

- Operating Pressure Range: 20 – 70 PSI (1,4 – 4,8 bar)
- Inlet: 1/2" (1,3 cm) female thread NPT

Models

- 73001** 3" (7,6 cm) Pop-Up
- 74001** 4" (10 cm) Pop-Up
- 76001** 6" (15 cm) Pop-Up
- 71201** 12" (30,5 cm) Pop-Up

How to Specify with Options

MODELS	OPTIONS
73001	-CV ▶ Check Valve
74001	-RCW ▶ Reclaimed Water Use
76001	
71201	

Examples: 73001-CV, 71201-RCW

Accessories

See page 34

Fast Facts

ALL	INLET: 1/2" (1,3 CM) FEMALE THREAD NPT	
73001	Retracted height:	4 3/4" (12,1 cm)
	Riser height:	2 1/2" (6,4 cm)
74001	Retracted height:	5 7/8" (14,9 cm)
	Riser height:	4" (10,2 cm)
76001	Retracted height:	8" (20,3 cm)
	Riser height:	5 7/8" (14,9 cm)
71201	Retracted height:	15 3/4" (40 cm)
	Riser height:	11 1/2" (29,2 cm)



Spray Accessories

Models

SHRUB ADAPTERS

- PSA** Shrub Adapter, Female Thread (for male nozzles)
- PFSA** Shrub Adapter, Male Thread (for female nozzles)
- PSA-RCW** RCW Shrub adapter, Female Thread, (for male nozzles)
- PFSA-RCW** RCW Shrub adapter, Male Thread, (for female nozzles)



CHECK DISKS

- P53426** K-Spray™ Check Valve
- P53428** Pro-S™ Check Valve
- P53429** NP Spray™ Check Valve



NOZZLE GUARD

- 78000** Nozzle Guard (fits Pro-S™ Sprays)
- 78000-RCW** Nozzle Guard for Reclaimed Water (Does not include riser seal)



SWING PIPE & FITTINGS

- KA05100** Swing Pipe, 1/2" x 100' Roll
- SWPC050** Swing Pipe, Coupling, 1/2" Barb
- SWPT050** Swing Pipe, Tee, 1/2" Barb
- SWPE050** Swing Pipe, Elbow, 1/2" MNPT x 1/2" Barb
- SWPE075** Swing Pipe, Elbow, 3/4" MNPT x 1/2" Barb
- SWPA060505** Swing Pipe Assembly, 6in, 1/2" Inlet x 1/2" Outlet
- SWPA060575** Swing Pipe Assembly, 6in, 1/2" Inlet x 3/4" Outlet
- SWPA067575** Swing Pipe Assembly, 6in, 3/4" Inlet x 3/4" Outlet
- SWPA120505** Swing Pipe Assembly, 12in, 1/2" Inlet x 1/2" Outlet
- SWPA120575** Swing Pipe Assembly, 12in, 1/2" Inlet x 3/4" Outlet
- SWPA127575** Swing Pipe Assembly, 12in, 3/4" Inlet x 3/4" Outlet
- SWPA180505** Swing Pipe Assembly, 18in, 1/2" Inlet x 1/2" Outlet
- SWPA187575** Swing Pipe Assembly, 18in, 3/4" Inlet x 3/4" Outlet

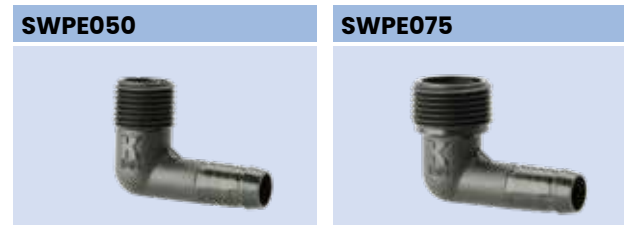
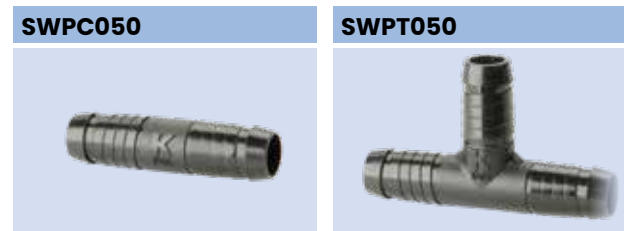



NOZZLES

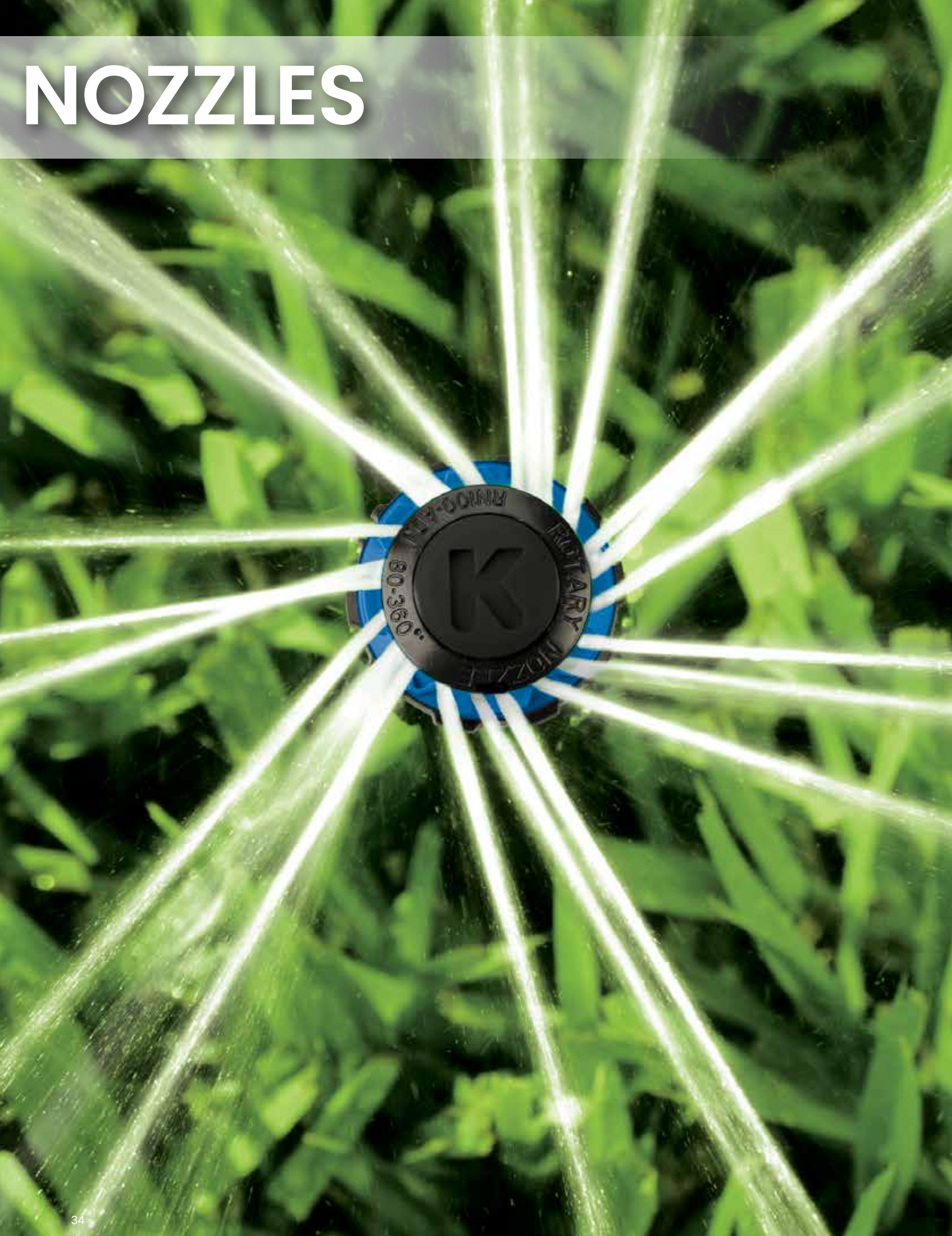

Nozzle | Comparison Chart

Designed with the utmost attention to detail, the versatility of the K-Rain® nozzle line ensures that the professional has everything needed for a variety of residential and commercial terrains.

	Rotary Nozzle Series	Fully Adjustable Rotary Nozzle	KVF Adjustable Nozzles	KV Adjustable Nozzles	Fixed Pattern Nozzles
	Full 360° & Adjustable	Fully Adjustable	Fully Adjustable	Fully Adjustable	Fixed Spray
Specifications					
Arc	90° - 360°	80° - 360°	0° - 360°	0° - 360°	90° - 360°
Radius	8' - 28'	13' - 30'	6' - 18'	7' - 20'	6' - 17'
Thread	female	female	female	male	female & male
Special patterns	right, left & side strip				center, end, side & high/low strip
Features					
Color-coded	•	•	•	•	•
Automatic matched precipitation	•	•	•	•	•
Warranty	3 years	3 years	7 years	7 years	7 years

Rotary Nozzle Series

Superior uniformity for demanding low-precipitation applications.

Features

- **Patented Flow Control** – Improved radius adjustment
- **Durable Design** – Molded with high-impact engineered resin for long life
- **Superior Uniformity** – Multi-stream technology provides outstanding coverage eliminating brown spots
- **Matched Precipitation** – Low precipitation rate is proportionate even after arc and radius adjustment
- **Water-smart Technology** – Reduce water usage up to 30% without compromising on results
- **Double pop-up Design** – Delivers additional protection from dirt/particulate intrusion in all conditions
- **Simple to Adjust** – Easiest adjustment in the industry – Hand adjustable/no tool required
- **Color-Coded** – Easily identify 9 standard nozzles and 3 specialty nozzles in the field
- **Recommended Operating Pressure** – 40 PSI (2,8 bar)



WATCH VIDEO

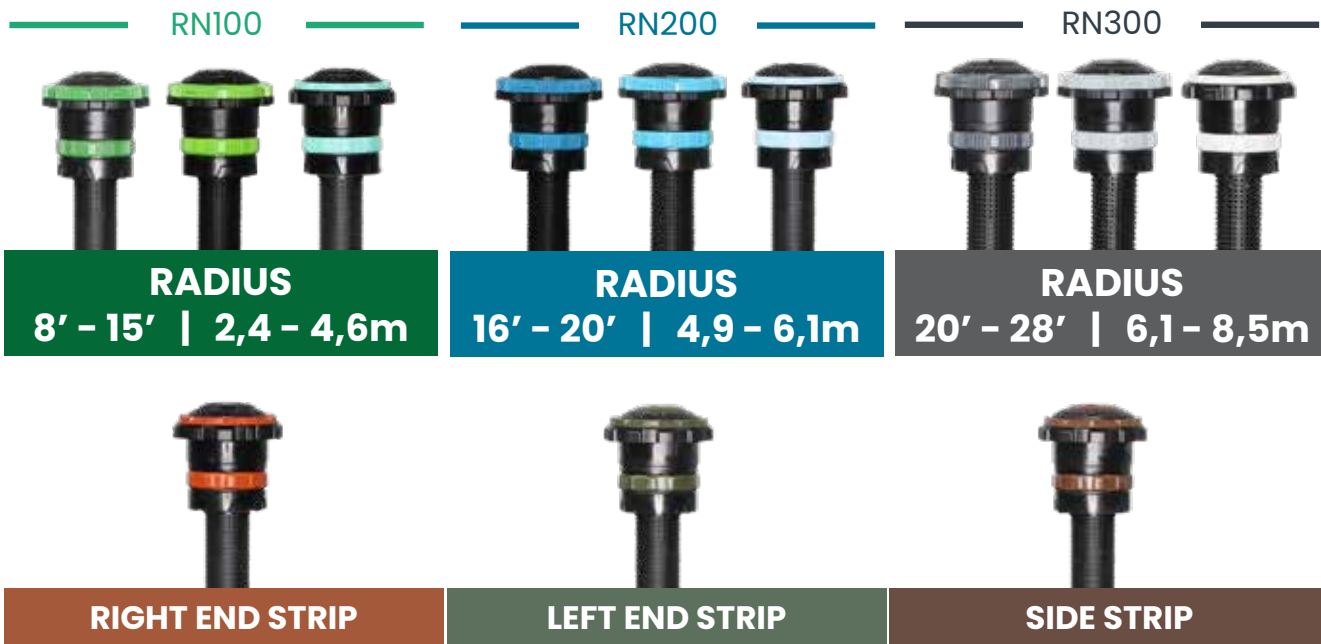

Models

RN100-ADJ-90-210

90°-210° Adjustable
8' - 15' (2,4 - 4,6 m)
■ Dark Green

RN100-ADJ-210-270

210°-270° Adjustable
8' - 15' (2,4 - 4,6 m)
■ Medium Green

RN100-FIX360

360° Fixed Pattern
8' - 15' (2,4 - 4,6 m)
■ Light Green

RN200-ADJ-90-210

90°-210° Adjustable
16' - 20' (4,9 - 6,1 m)
■ Dark Blue

RN200-ADJ-210-270

210°-270° Adjustable
16' - 20' (4,9 - 6,1 m)
■ Medium Blue

RN200-FIX360

360° Fixed Pattern
16' - 20' (4,9 - 6,1 m)
■ Light Blue

RN300-ADJ-90-210

90°-210° Adjustable
20' - 28' (6,1 - 8,5 m)
■ Dark Gray

RN300-ADJ-210-270

210°-270° Adjustable
20' - 28' (6,1 - 8,5 m)
■ Medium Gray

RN300-FIX360

360° Fixed Pattern
20' - 28' (6,1 - 8,5 m)
■ Light Gray

RNS-RES-515

Right End Strip
■ Burnt Orange

RNS-LES-515

Left End Strip
■ Olive

RNS-SS-530

Side Strip
■ Brown

Performance Data - U.S.

RN100-ADJ-90-210 ■ Dark Green

ARC DEGREE	PRESSURE		RADIUS	FLOW	PRECIP in/hr	
	PSI	FEET	FT	GPM	■	▲
90°	30	13	0.23	0.51	0.59	
	35	14	0.25	0.48	0.56	
	40	15	0.26	0.44	0.51	
	45	15	0.28	0.48	0.55	
	50	16	0.30	0.45	0.52	
180°	30	13	0.45	0.51	0.59	
	35	14	0.48	0.47	0.54	
	40	14	0.51	0.50	0.58	
	45	15	0.55	0.47	0.54	
	50	15	0.59	0.50	0.58	
210°	30	13	0.52	0.51	0.59	
	35	14	0.56	0.47	0.54	
	40	14	0.58	0.49	0.56	
	45	14	0.62	0.52	0.60	
	50	15	0.68	0.50	0.58	

Performance Data - U.S.

RN100-ADJ-210-270 ■ Medium Green

ARC DEGREE	PRESSURE		RADIUS	FLOW	PRECIP in/hr	
	PSI	FEET	FT	GPM	■	▲
210°	30	13	0.52	0.51	0.59	
	35	14	0.56	0.47	0.54	
	40	14	0.58	0.49	0.56	
	45	14	0.62	0.52	0.60	
	50	15	0.68	0.50	0.53	
270°	30	13	0.68	0.51	0.59	
	35	14	0.71	0.46	0.54	
	40	14	0.75	0.49	0.57	
	45	14	0.79	0.52	0.60	
	50	15	0.86	0.49	0.57	

Performance Data - U.S.

RN100-FIX360 ■ Light Green

ARC DEGREE	PRESSURE		RADIUS	FLOW	PRECIP in/hr	
	PSI	FEET	FT	GPM	■	▲
360°	30	13	.88	.50	.58	
	35	14	.94	.46	.53	
	40	14	1.00	.49	.57	
	45	15	1.15	.49	.57	
	50	15	1.20	.51	.59	

Performance Data - U.S.

RN200-ADJ-90-210 ■ Dark Blue

ARC DEGREE	PRESSURE		RADIUS	FLOW	PRECIP in/hr	
	PSI	FEET	FT	GPM	■	▲
90°	30	19	0.38	0.41	0.47	
	35	19	0.42	0.45	0.52	
	40	20	0.45	0.43	0.50	
	45	20	0.48	0.46	0.53	
	50	21	0.51	0.45	0.51	
180°	30	19	0.75	0.40	0.46	
	35	20	0.80	0.39	0.44	
	40	20	0.85	0.41	0.47	
	45	21	0.90	0.39	0.45	
	50	21	1.00	0.44	0.50	
210°	30	18	0.89	0.45	0.52	
	35	19	0.95	0.43	0.50	
	40	20	1.00	0.41	0.48	
	45	20	1.05	0.43	0.50	
	50	21	1.10	0.41	0.48	

Performance Data - U.S.

RN200-ADJ-210-270 ■ Medium Blue

ARC DEGREE	PRESSURE		RADIUS	FLOW	PRECIP in/hr	
	PSI	FEET	FT	GPM	■	▲
210°	30	18	0.89	0.45	0.52	
	35	19	0.95	0.43	0.50	
	40	20	1.00	0.41	0.48	
	45	20	1.05	0.43	0.50	
	50	21	1.10	0.41	0.48	
270°	30	17	1.10	0.49	0.56	
	35	18	1.20	0.48	0.55	
	40	19	1.30	0.46	0.53	
	45	19	1.40	0.50	0.57	
	50	19	1.45	0.52	0.60	

Performance Data - U.S.

RN200-FIX360 ■ Light Blue

ARC DEGREE	PRESSURE		RADIUS	FLOW	PRECIP in/hr	
	PSI	FEET	FT	GPM	■	▲
360°	30	16	1.34	.50	.58	
	35	17	1.50	.50	.58	
	40	18	1.65	.49	.57	
	45	19	1.68	.45	.52	
	50	19	1.88	.50	.58	

Performance Data - U.S.

RN300-ADJ-90-210 ■ Dark Gray

ARC DEGREE	PRESSURE		RADIUS	FLOW	PRECIP in/hr	
	PSI	FEET	FT	GPM	■	▲
90°	30	27	0.90	0.48	0.55	
	35	27	0.95	0.50	0.58	
	40	28	1.00	0.49	0.57	
	45	28	1.05	0.52	0.60	
	50	29	1.10	0.50	0.58	
180°	30	26	1.65	0.47	0.54	
	35	26	1.75	0.50	0.58	
	40	27	1.86	0.49	0.57	
	45	27	1.95	0.51	0.59	
	50	28	2.10	0.52	0.60	
210°	30	25	1.81	0.48	0.55	
	35	26	1.95	0.48	0.55	
	40	27	2.15	0.49	0.56	
	45	27	2.30	0.52	0.60	
	50	28	2.40	0.51	0.58	

Performance Data - U.S.

RN300-ADJ-210-270 ■ Medium Gray

ARC DEGREE	PRESSURE		RADIUS	FLOW	PRECIP in/hr	
	PSI	FEET	FT	GPM	■	▲
210°	30	25	1.81	0.48	0.55	
	35	26	1.95	0.48	0.55	
	40	27	2.15	0.49	0.56	
	45	27	2.30	0.52	0.60	
	50	28	2.40	0.51	0.58	
270°	30	25	2.40	0.49	0.57	
	35	26	2.55	0.48	0.56	
	40	27	2.70	0.48	0.55	
	45	27	2.87	0.51	0.58	
	50	27	3.00	0.53	0.61	

Performance Data - U.S.

RN300-FIX360 ■ Light Gray

ARC DEGREE	PRESSURE		RADIUS	FLOW	PRECIP in/hr	
	PSI	FEET	FT	GPM	■	▲
360°	30	26	3.10	.44	.51	
	35	27	3.20	.42	.49	
	40	28	3.50	.43	.50	
	45	28	3.55	.44	.50	
	50	30	3.70	.40	.46	

Performance Data - U.S.

Special Patterns

RNS-RES-515 ■ Burnt Orange

PATTERN	NOZZLE	PRESSURE		W X L	FLOW
		PSI	FEET	FT	GPM
RIGHT END STRIP		30	4 x 15	.30	
		35	5 x 15	.32	
		40	5 x 15	.35	
		45	6 x 16	.38	
		50	6 x 16	.40	

Performance Data - U.S.

Special Patterns

RNS-LES-515 ■ Olive

PATTERN	NOZZLE	PRESSURE		W X L	FLOW
		PSI	FEET	FT	GPM
LEFT END STRIP		30	4 x 15	.30	
		35	5 x 15	.32	
		40	5 x 15	.35	
		45	6 x 15	.38	
		50	6 x 16	.40	

Performance Data - U.S.

Special Patterns

RNS-SS-530 ■ Brown

PATTERN	NOZZLE	PRESSURE		W X L	FLOW
		PSI	FEET	FT	GPM
SIDE STRIP		30	4 x 29	.50	
		35	5 x 30	.55	
		40	5 x 30	.60	
		45	6 x 31	.65	
		50	7 x 32	.70	

Rotary Nozzle Series

Performance Data - Metric

RN100-ADJ-90-210 ■ Dark Green

ARC DEGREE	PRESSURE	RADIUS	FLOW	PRECIP mm/hr	
	Bar	METERS	L/M	■	▲
90°	2,1	4,0	0,85	13	15
	2,4	4,3	0,93	12	14
	2,8	4,6	0,98	11	13
	3,1	4,6	1,06	12	14
	3,4	4,9	1,14	11	13
180°	2,1	4,0	1,70	13	15
	2,4	4,3	1,82	12	14
	2,8	4,3	1,93	13	15
	3,1	4,6	2,08	12	14
	3,4	4,6	2,23	13	15
210°	2,1	4,0	1,97	13	15
	2,4	4,3	2,12	12	14
	2,8	4,3	2,20	12	14
	3,1	4,3	2,35	13	15
	3,4	4,6	2,57	13	15

Performance Data - Metric

RN100-ADJ-210-270 ■ Medium Green

ARC DEGREE	PRESSURE	RADIUS	FLOW	PRECIP mm/hr	
	Bar	METERS	L/M	■	▲
210°	2,1	4,0	1,97	13	15
	2,4	4,3	2,12	12	14
	2,8	4,3	2,20	12	14
	3,1	4,3	2,35	13	15
	3,4	4,6	2,57	13	15
270°	2,1	4,0	2,56	13	15
	2,4	4,3	2,69	12	14
	2,8	4,3	2,84	12	14
	3,1	4,3	2,99	13	15
	3,4	4,6	3,26	12	14

Performance Data - Metric

RN100-FIX360 ■ Light Green

ARC DEGREE	PRESSURE	RADIUS	FLOW	PRECIP mm/hr	
	Bar	METERS	L/M	■	▲
360°	2,1	4,0	3,33	13	15
	2,4	4,3	3,56	12	13
	2,8	4,3	3,79	12	14
	3,1	4,6	4,35	12	14
	3,4	4,6	4,54	13	15

Performance Data - Metric

RN200-ADJ-90-210 ■ Dark Blue

ARC DEGREE	PRESSURE	RADIUS	FLOW	PRECIP mm/hr	
	Bar	METERS	L/M	■	▲
90°	2,1	5,8	1,44	10	12
	2,4	5,8	1,59	11	13
	2,8	6,1	1,70	11	13
	3,1	6,1	1,82	12	14
	3,4	6,4	1,93	11	13
180°	2,1	5,8	2,84	10	12
	2,4	6,1	3,03	10	11
	2,8	6,1	3,22	10	12
	3,1	6,4	3,41	10	12
	3,4	6,4	3,79	11	13
210°	2,1	5,5	3,37	12	13
	2,4	5,8	3,60	11	13
	2,8	6,1	3,79	10	12
	3,1	6,1	3,97	11	13
	3,4	6,4	4,16	10	12

Performance Data - Metric

RN200-ADJ-210-270 ■ Medium Blue

ARC DEGREE	PRESSURE	RADIUS	FLOW	PRECIP mm/hr	
	Bar	METERS	L/M	■	▲
210°	2,1	5,5	3,37	12	13
	2,4	5,8	3,60	11	13
	2,8	6,1	3,79	10	12
	3,1	6,1	3,97	11	13
	3,4	6,4	4,16	10	12
270°	2,1	5,2	4,16	12	14
	2,4	5,5	4,54	12	14
	2,8	5,8	4,92	12	14
	3,1	5,8	5,30	13	15
	3,4	5,8	5,49	13	15

Performance Data - Metric

RN200-FIX360 ■ Light Blue

ARC DEGREE	PRESSURE	RADIUS	FLOW	PRECIP mm/hr	
	Bar	METERS	L/M	■	▲
360°	2,1	4,9	5,07	13	15
	2,4	5,2	5,68	13	15
	2,8	5,5	6,25	12	14
	3,1	5,8	6,36	11	13
	3,4	5,8	7,12	13	15

Performance Data - Metric

RN300-ADJ-90-210 ■ Dark Gray

ARC DEGREE	PRESSURE	RADIUS	FLOW	PRECIP mm/hr	
	Bar	METERS	L/M	■	▲
90°	2,1	8,2	3,41	12	14
	2,4	8,2	3,60	13	15
	2,8	8,5	3,79	12	14
	3,1	8,5	3,97	13	15
	3,4	8,8	4,16	13	15
180°	2,1	7,9	6,25	12	14
	2,4	7,9	6,62	13	15
	2,8	8,2	7,04	12	14
	3,1	8,2	7,38	13	15
	3,4	8,5	7,95	13	15
210°	2,1	7,6	6,85	12	14
	2,4	7,9	7,38	12	14
	2,8	8,2	8,14	12	14
	3,1	8,2	8,71	13	15
	3,4	8,5	9,08	13	15

Performance Data - Metric

RN300-ADJ-210-270 ■ Medium Gray

ARC DEGREE	PRESSURE	RADIUS	FLOW	PRECIP mm/hr	
	Bar	METERS	L/M	■	▲
210°	2,1	7,6	6,85	12	14
	2,4	7,9	7,38	12	14
	2,8	8,2	8,14	12	14
	3,1	8,2	8,71	13	15
	3,4	8,5	9,08	13	15
270°	2,1	7,6	9,08	13	14
	2,4	7,9	9,65	12	14
	2,8	8,2	10,22	12	14
	3,1	8,2	10,86	13	15
	3,4	8,2	11,36	13	15

Performance Data - Metric

RN300-FIX360 ■ Light Gray

ARC DEGREE	PRESSURE	RADIUS	FLOW	PRECIP mm/hr	
	Bar	METERS	L/M	■	▲
360°	2,1	7,9	11,73	11	13
	2,4	8,2	12,11	11	12
	2,8	8,5	13,25	11	13
	3,1	8,5	13,44	11	13
	3,4	9,1	14,01	10	12

Performance Data - Metric

Special Patterns

RNS-RES-515 ■ Burnt Orange

PATTERN	NOZZLE	PRESSURE	W X L	FLOW
		Bar	METERS	L/M
RIGHT END STRIP		2,1	1,2 x 4,6	1,14
		2,4	1,5 x 4,6	1,21
		2,8	1,5 x 4,6	1,32
		3,1	1,8 x 4,9	1,43
		3,4	1,8 x 4,9	1,51

Performance Data - Metric

Special Patterns

RNS-LES-515 ■ Olive

PATTERN	NOZZLE	PRESSURE	W X L	FLOW
		Bar	METERS	L/M
LEFT END STRIP		2,1	1,2 x 4,6	1,14
		2,4	1,5 x 4,6	1,21
		2,8	1,5 x 4,6	1,32
		3,1	1,8 x 4,6	1,43
		3,4	1,8 x 4,9	1,51

Performance Data - Metric

Special Patterns

RNS-SS-530 ■ Brown

PATTERN	NOZZLE	PRESSURE	W X L	FLOW
		Bar	METERS	L/M
SIDE STRIP		2,1	1,2 x 8,8	1,80
		2,4	1,5 x 9,1	2,08
		2,8	1,5 x 9,1	2,30
		3,1	1,8 x 9,4	2,46
		3,4	2,1 x 9,7	2,64



Fully Adjustable Rotary Nozzles

The only fully adjustable rotary nozzle from 80° – 360°.

Features

- Fully adjustable 80° to 360° – only one SKU per distance
- Female Threaded – fits any male threaded spray body
- Hand adjustable – no tools needed
- Radius adjustment up to 30% – patented flow control
- Arc adjustment wet or dry – visual left start and right stop
- Double pop-up system – superior dirt tolerance
- Three model options – distances from 13' to 30' (3,96 m to 9,14 m)
- Recommended Operating Pressure – 30 PSI (2,1 bar)
- Matched precipitation – superior efficiency in water and uniformity through all patterns and distances
- Low precipitation rate – reduces runoff and improves soil absorption
- Low flow rate – allows for more heads per zone, fewer zones
- Viscous dampening – helps ensure consistent application speed over varying flow rates and pressures
- Multiple stream technology – for improved wind resistance
- Large filter – prolongs product life



Models

RN100-ADJ

80°-360° Adjustable
13' – 15' (4 – 4,6 m)

 Green

RN200-ADJ

80°-360° Adjustable
16' – 19' (4,9 – 5,8 m)

 Blue

RN300-ADJ

80°-360° Adjustable
26' – 30' (7,9 – 9,1 m)

 Red



WATCH VIDEO

RN100-ADJ



13' - 15' (4-4,6 m)

Performance Data - U.S.

NOZZLE	PRESSURE	RADIUS	FLOW	PRECIP in/hr	
	PSI	FEET	GPM	■	▲
90°	30	13	0.22	0.50	0.58
	40	14	0.25	0.49	0.57
	50	15	0.30	0.51	0.59
180°	30	13	0.44	0.50	0.58
	40	14	0.50	0.49	0.57
	50	15	0.60	0.51	0.59
360°	30	13	0.90	0.51	0.59
	40	14	1.00	0.49	0.57
	50	15	1.20	0.51	0.59

Performance Data - Metric

NOZZLE	PRESSURE	RADIUS	FLOW	PRECIP mm/hr	
	BAR	METERS	L/M	■	▲
90°	2,1	3,96	0,83	13	15
	2,8	4,27	0,95	12	14
	3,5	4,57	1,14	13	15
180°	2,1	3,96	1,67	13	15
	2,8	4,27	1,89	12	14
	3,5	4,57	2,27	13	15
360°	2,1	3,96	3,41	13	15
	2,8	4,27	3,79	12	14
	3,5	4,57	4,54	13	15

RN200-ADJ



16' - 19' (4,9-5,8 m)

Performance Data - U.S.

NOZZLE	PRESSURE	RADIUS	FLOW	PRECIP in/hr	
	PSI	FEET	GPM	■	▲
90°	30	16	0.34	0.51	0.59
	40	18	0.41	0.49	0.56
	50	19	0.47	0.50	0.58
180°	30	16	0.67	0.50	0.58
	40	18	0.83	0.49	0.57
	50	19	0.94	0.50	0.58
360°	30	16	1.35	0.51	0.59
	40	18	1.70	0.51	0.58
	50	19	1.90	0.51	0.58

Performance Data - Metric

NOZZLE	PRESSURE	RADIUS	FLOW	PRECIP mm/hr	
	BAR	METERS	L/M	■	▲
90°	2,1	4,88	1,29	13	15
	2,8	5,49	1,55	12	14
	3,5	5,79	1,78	13	15
180°	2,1	4,88	2,54	13	15
	2,8	5,49	3,14	12	14
	3,5	5,79	3,56	13	15
360°	2,1	4,88	5,11	13	15
	2,8	5,49	6,44	13	15
	3,5	5,79	7,19	13	15

RN300-ADJ



26' - 30' (7,9-9,1 m)

Performance Data - U.S.

NOZZLE	PRESSURE	RADIUS	FLOW	PRECIP in/hr	
	PSI	FEET	GPM	■	▲
90°	30	26	0.80	0.46	0.53
	40	27	0.90	0.48	0.55
	50	29	1.00	0.46	0.53
180°	30	26	1.50	0.43	0.49
	40	27	1.60	0.42	0.49
	50	29	1.80	0.41	0.48
360°	30	26	3.00	0.43	0.49
	40	27	3.20	0.42	0.49
	50	28	3.80	0.47	0.54

Performance Data - Metric

NOZZLE	PRESSURE	RADIUS	FLOW	PRECIP mm/hr	
	BAR	METERS	L/M	■	▲
90°	2,1	7,92	3,03	12	13
	2,8	8,23	3,41	12	14
	3,5	8,84	3,79	12	13
180°	2,1	7,92	5,68	11	12
	2,8	8,23	6,06	11	12
	3,5	8,84	6,81	10	12
360°	2,1	7,92	11,36	11	12
	2,8	8,23	12,11	11	12
	3,5	8,83	14,38	12	14

*Data represents test results in zero wind. Adjust for local conditions.



KVF Nozzles

Complete flexibility for working in a variety of terrains.

Features

- Superior Spray Patterns
- Fits any male-threaded spray body
- Color-coded for Easy Identification
- Uniform Water Distribution
- Water Efficient Low Flow Rates
- Extra Long Filters Extend Time Between Cleanings
- Recommended Operating Pressure – 30 PSI (2,1 bar)

Models

KVF6
6' (1,8 m) Nozzle
■ Red

KVF8
8' (2,4 m) Nozzle
■ Green

KVF10
10' (3 m) Nozzle
■ Blue

KVF12
12' (3,7 m) Nozzle
■ Brown

KVF15
15' (4,6 m) Nozzle
■ Black

KVF17
17' (5,2 m) Nozzle
■ Gray

Performance Data – U.S.

KVF6 6' (1,8 m) Nozzle (red)

ARC DEGREE	PRESSURE	RADIUS	FLOW	PRECIP in/hr	
	PSI	FEET	GPM	■	▲
90°	20	5	0.36	5.54	6.40
	25	5	0.43	6.16	7.65
	30	6	0.50	5.35	6.17
	40	6	0.59	6.31	7.29
180°	20	5	0.60	4.61	5.33
	25	5	0.66	5.07	5.86
	30	6	0.74	3.95	4.56
	40	6	0.86	4.59	5.30
270°	20	5	0.80	4.10	4.74
	25	5	0.89	4.56	5.27
	30	6	0.97	3.45	3.99
	40	6	1.20	4.27	4.93
360°	20	5	1.08	4.15	4.79
	25	5	1.25	4.81	5.55
	30	6	1.37	3.66	4.22
	40	6	1.62	4.33	4.99

Performance Data – U.S.

KVF8 8' (2,4 m) Nozzle (green)

ARC DEGREE	PRESSURE	RADIUS	FLOW	PRECIP in/hr	
	PSI	FEET	GPM	■	▲
90°	20	9	0.39	1.85	2.14
	25	10	0.42	1.62	1.87
	30	10	0.50	1.93	2.22
	40	11	0.61	1.94	2.24
180°	20	9	0.75	1.78	2.06
	25	9	0.85	2.02	2.33
	30	10	1.00	1.93	2.22
	40	10	1.16	2.23	2.58
270°	20	9	1.15	1.82	2.10
	25	9	1.25	1.98	2.29
	30	10	1.50	1.93	2.22
	40	10	1.75	2.25	2.59
360°	20	9	1.50	1.78	2.06
	25	9	1.70	2.02	2.33
	30	10	2.00	1.93	2.22
	40	10	2.30	2.21	2.56

Performance Data – U.S.

KVF10 10' (3 m) Nozzle (blue)

ARC DEGREE	PRESSURE	RADIUS	FLOW	PRECIP in/hr	
	PSI	FEET	GPM	■	▲
90°	20	10	0.45	1.73	2.00
	25	11	0.54	1.72	1.98
	30	12	0.62	1.66	1.91
	40	12	0.70	1.87	2.16
180°	20	10	0.90	1.73	2.00
	25	11	1.10	1.75	2.02
	30	12	1.25	1.67	1.93
	40	12	1.40	1.87	2.16
270°	20	10	1.35	1.73	2.00
	25	11	1.65	1.75	2.02
	30	12	1.85	1.65	1.90
	40	12	2.10	1.87	2.16
360°	20	10	1.80	1.73	2.00
	25	11	2.20	1.75	2.02
	30	12	2.50	1.67	1.93
	40	12	2.80	1.87	2.16

Performance Data – Metric

KVF6 6' (1,8 m) Nozzle (red)

ARC DEGREE	PRESSURE	RADIUS	FLOW	PRECIP mm/hr	
	BAR	METERS	L/M	■	▲
90°	1,38	1,5	1,36	141	163
	1,72	1,5	1,63	156	194
	2,07	1,8	1,89	136	157
	2,76	1,8	2,23	160	185
180°	1,38	1,5	2,27	117	135
	1,72	1,5	2,50	129	149
	2,07	1,8	2,80	100	116
	2,76	1,8	3,26	117	135
270°	1,38	1,5	3,03	104	120
	1,72	1,5	3,37	116	134
	2,07	1,8	3,67	88	101
	2,76	1,8	4,54	108	125
360°	1,38	1,5	4,09	105	122
	1,72	1,5	4,73	122	141
	2,07	1,8	5,19	93	107
	2,76	1,8	6,13	110	127

Performance Data – Metric

KVF8 8' (2,4 m) Nozzle (green)

ARC DEGREE	PRESSURE	RADIUS	FLOW	PRECIP mm/hr	
	BAR	METERS	L/M	■	▲
90°	1,38	2,7	1,48	47	54
	1,72	3,1	1,59	41	47
	2,07	3,1	1,89	49	56
	2,76	3,4	2,31	49	57
180°	1,38	2,7	2,84	45	52
	1,72	2,7	3,22	51	59
	2,07	3,1	3,79	49	56
	2,76	3,1	4,39	57	65
270°	1,38	2,7	4,35	46	53
	1,72	2,7	4,73	50	58
	2,07	3,1	5,68	49	56
	2,76	3,1	6,62	57	66
360°	1,38	2,7	5,68	45	52
	1,72	2,7	6,44	51	59
	2,07	3,1	7,57	49	56
	2,76	3,1	8,71	56	65

Performance Data – Metric

KVF10 10' (3 m) Nozzle (blue)

ARC DEGREE	PRESSURE	RADIUS	FLOW	PRECIP mm/hr	
	BAR	METERS	L/M	■	▲
90°	1,38	3,1	1,70	44	51
	1,72	3,4	2,04	44	50
	2,07	3,7	2,35	42	49
	2,76	3,7	2,65	47	55
180°	1,38	3,1	3,41	44	51
	1,72	3,4	4,16	44	51
	2,07	3,7	4,73	42	49
	2,76	3,7	5,30	47	55
270°	1,38	3,1	5,11	44	51
	1,72	3,4	6,25	44	51
	2,07	3,7	7,00	42	48
	2,76	3,7	7,95	47	55
360°	1,38	3,1	6,81	44	51
	1,72	3,4	8,33	44	51
	2,07	3,7	9,46	42	49
	2,76	3,7	10,60	47	55

*Data represents test results in zero wind. Radius may be reduced with the radius reduction screw.
Bold = recommended pressure of 30 PSI

Performance Data – U.S.

KVF12 12' (3,7 m) Nozzle (brown)

ARC DEGREE	PRESSURE	RADIUS	FLOW	PRECIP in/hr	
	PSI	FEET	GPM	■	▲
90°	20	12	0.65	1.74	2.01
	25	13	0.70	1.59	1.84
	30	14	0.80	1.57	1.81
	40	14	0.90	1.77	2.04
180°	20	12	1.30	1.74	2.01
	25	13	1.40	1.59	1.84
	30	14	1.60	1.57	1.81
	40	14	1.80	1.77	2.04
270°	20	12	1.90	1.69	1.96
	25	13	2.10	1.59	1.84
	30	14	2.40	1.57	1.81
	40	14	2.60	1.70	1.97
360°	20	12	2.20	1.47	1.70
	25	13	2.60	1.48	1.71
	30	14	3.10	1.52	1.76
	40	14	3.50	1.72	1.98

Performance Data – Metric

KVF12 12' (3,7 m) Nozzle (brown)

ARC DEGREE	PRESSURE	RADIUS	FLOW	PRECIP mm/hr	
	BAR	METERS	L/M	■	▲
90°	1,38	3,7	2,46	44	51
	1,72	4,0	2,65	40	47
	2,07	4,3	3,03	40	46
	2,76	4,3	3,41	45	52
180°	1,38	3,7	4,92	44	51
	1,72	4,0	5,30	40	47
	2,07	4,3	6,06	40	46
	2,76	4,3	6,81	45	52
270°	1,38	3,7	7,19	43	50
	1,72	4,0	7,95	40	47
	2,07	4,3	9,08	40	46
	2,76	4,3	9,84	43	50
360°	1,38	3,7	8,33	37	43
	1,72	4,0	9,84	38	43
	2,07	4,3	11,73	39	45
	2,76	4,3	13,25	44	50

Performance Data – U.S.

KVF15 15' (4,6 m) Nozzle (black)

ARC DEGREE	PRESSURE	RADIUS	FLOW	PRECIP in/hr	
	PSI	FEET	GPM	■	▲
90°	20	14	0.75	1.47	1.70
	25	15	0.85	1.45	1.68
	30	15	0.95	1.63	1.88
	40	17	1.10	1.47	1.69
180°	20	14	1.40	1.38	1.59
	25	15	1.70	1.45	1.68
	30	15	1.90	1.63	1.88
	40	17	2.30	1.53	1.77
270°	20	14	2.25	1.47	1.70
	25	15	2.55	1.45	1.68
	30	15	2.80	1.60	1.84
	40	17	3.40	1.51	1.74
360°	20	14	3.00	1.47	1.70
	25	15	3.40	1.45	1.68
	30	15	3.80	1.63	1.88
	40	17	4.60	1.53	1.77

Performance Data – Metric

KVF15 15' (4,6 m) Nozzle (black)

ARC DEGREE	PRESSURE	RADIUS	FLOW	PRECIP mm/hr	
	BAR	METERS	L/M	■	▲
90°	1,38	4,3	2,84	37	43
	1,72	4,6	3,22	37	43
	2,07	4,6	3,60	41	48
	2,76	5,2	4,16	37	43
180°	1,38	4,3	5,30	35	40
	1,72	4,6	6,44	37	43
	2,07	4,6	7,19	41	48
	2,76	5,2	8,71	39	45
270°	1,38	4,3	8,52	37	43
	1,72	4,6	9,65	37	43
	2,07	4,6	10,60	41	47
	2,76	5,2	12,87	38	44
360°	1,38	4,3	11,36	37	43
	1,72	4,6	12,87	37	43
	2,07	4,6	14,38	41	48
	2,76	5,2	17,41	39	45

Performance Data – U.S.

KVF17 17' (5,2 m) Nozzle (gray)

ARC DEGREE	PRESSURE	RADIUS	FLOW	PRECIP in/hr	
	PSI	FEET	GPM	■	▲
90°	20	17	0.85	1.13	1.31
	25	17	0.95	1.27	1.46
	30	18	1.05	1.25	1.44
	40	18	1.20	1.43	1.65
180°	20	16	1.70	1.28	1.48
	25	17	1.90	1.27	1.46
	30	18	2.10	1.25	1.44
	40	18	2.40	1.43	1.65
270°	20	16	2.50	1.25	1.45
	25	17	2.80	1.24	1.44
	30	18	3.15	1.25	1.44
	40	18	3.60	1.43	1.65
360°	20	16	3.40	1.28	1.48
	25	17	3.80	1.27	1.46
	30	18	4.20	1.25	1.44
	40	18	4.80	1.43	1.65

Performance Data – Metric

KVF17 17' (5,2 m) Nozzle (gray)

ARC DEGREE	PRESSURE	RADIUS	FLOW	PRECIP mm/hr	
	BAR	METERS	L/M	■	▲
90°	1,38	5,2	3,22	29	33
	1,72	5,2	3,60	32	37
	2,07	5,5	3,97	32	37
	2,76	5,5	4,54	36	42
180°	1,38	4,9	6,44	32	37
	1,72	5,2	7,19	32	37
	2,07	5,5	7,95	32	37
	2,76	5,5	9,08	36	42
270°	1,38	4,9	9,46	32	37
	1,72	5,2	10,60	32	36
	2,07	5,5	11,92	32	37
	2,76	5,5	13,63	36	42
360°	1,38	4,9	12,87	32	37
	1,72	5,2	14,38	32	37
	2,07	5,5	15,90	32	37
	2,76	5,5	18,17	36	42



*Data represents test results in zero wind. Radius may be reduced with the radius reduction screw.
Bold = recommended pressure of 30 PSI.

KV Nozzles

Adjustable pattern, male-threaded nozzles.

Features

- Superior Spray Patterns
- Fits any female-threaded spray body
- Color-coded for Easy Identification
- Extra Long Filters Extend Time Between Cleanings
- Recommended Operating Pressure – 30 PSI (2,1 bar)

Performance Data – U.S.

KV8 8' (2,4 m) Nozzle (Green)

ARC DEGREE	PRESSURE		RADIUS FEET	FLOW GPM	PRECIP in/hr	
	PSI	BAR			■	▲
90°	20	1,38	7	0.30	2.36	2.72
	30	2,07	8	0.40	2.41	2.78
	40	2,76	8	0.40	2.41	2.78
	50	3,45	9	0.40	1.9	2.2
180°	20	1,38	7	0.80	3.14	3.63
	30	2,07	8	0.90	2.71	3.13
	40	2,76	8	1.00	3.01	3.47
	50	3,45	9	1.10	2.61	3.02
270°	20	1,38	7	1.20	3.14	3.63
	30	2,07	8	1.20	2.41	2.78
	40	2,76	8	1.30	2.61	3.01
	50	3,45	9	1.50	2.38	2.74
360°	20	1,38	7	1.90	3.73	4.31
	30	2,07	8	2.00	3.01	3.47
	40	2,76	8	2.20	3.31	3.82
	50	3,45	9	2.30	2.73	3.16

Performance Data – Metric

KV8 8' (2,4 m) Nozzle (Green)

ARC DEGREE	PRESSURE		RADIUS METERS	FLOW L/M	PRECIP mm/hr	
	BAR	PSI			■	▲
90°	1,38	20	2,1	1,14	60	69
	2,07	30	2,4	1,51	61	70
	2,76	40	2,4	1,51	61	70
	3,45	50	2,7	1,51	48	56
180°	1,38	20	2,1	3,03	80	92
	2,07	30	2,4	3,41	69	79
	2,76	40	2,4	3,79	76	88
	3,45	50	2,7	4,16	66	77
270°	1,38	20	2,1	4,54	80	92
	2,07	30	2,4	4,54	61	70
	2,76	40	2,4	4,92	66	76
	3,45	50	2,7	5,68	60	70
360°	1,38	20	2,1	7,19	95	109
	2,07	30	2,4	7,57	76	88
	2,76	40	2,4	8,33	84	97
	3,45	50	2,7	8,71	69	80

Models

KV8
8' (2,4 m) Nozzle,
■ **Green**

KV10
10' (3 m) Nozzle,
■ **Blue**

KV12
12' (3,7 m) Nozzle,
■ **Brown**

KV15
15' (4,6 m) Nozzle,
■ **Black**

KV17
17' (5,2 m) Nozzle,
■ **Gray**

Performance Data – U.S.

KV10 10' (3 m) Nozzle (Blue)

ARC DEGREE	PRESSURE		RADIUS FEET	FLOW GPM	PRECIP in/hr	
	PSI	BAR			■	▲
90°	20	1,38	12	0.70	1.87	2.16
	30	2,07	12	1.10	2.94	3.40
	40	2,76	13	1.40	3.19	3.68
	50	3,45	14	1.50	2.95	3.40
180°	20	1,38	11	1.40	2.23	2.57
	30	2,07	11	1.60	2.55	2.94
	40	2,76	12	1.80	2.41	2.78
	50	3,45	13	2.00	2.28	2.63
270°	20	1,38	10	1.70	2.18	2.52
	30	2,07	10	2.00	2.57	2.96
	40	2,76	11	2.30	2.44	2.82
	50	3,45	12	2.60	2.32	2.68
360°	20	1,38	10	2.20	2.12	2.45
	30	2,07	10	2.70	2.60	3.00
	40	2,76	11	3.00	2.39	2.76
	50	3,45	12	3.50	2.34	2.70

Performance Data – Metric

KV10 10' (3 m) Nozzle (Blue)

ARC DEGREE	PRESSURE		RADIUS METERS	FLOW L/M	PRECIP mm/hr	
	BAR	PSI			■	▲
90°	1,38	20	3,7	2,65	47	55
	2,07	30	3,7	4,16	75	86
	2,76	40	4,0	5,30	81	93
	3,45	50	4,3	5,68	75	86
180°	1,38	20	3,4	5,30	56	65
	2,07	30	3,4	6,06	65	75
	2,76	40	3,7	6,81	61	70
	3,45	50	4,0	7,57	58	67
270°	1,38	20	3,1	6,44	55	64
	2,07	30	3,1	7,57	65	75
	2,76	40	3,4	8,71	62	71
	3,45	50	3,7	9,84	59	68
360°	1,38	20	3,1	8,33	54	62
	2,07	30	3,1	10,22	66	76
	2,76	40	3,4	11,36	61	70
	3,45	50	3,7	13,25	59	69

Performance Data – U.S.

KV12 12' (3,7 m) Nozzle (Brown)

ARC DEGREE	PRESSURE		RADIUS FEET	FLOW GPM	PRECIP in/hr	
	PSI	BAR			■	▲
90°	20	1,38	12	1.10	2.94	3.40
	30	2,07	13	1.30	2.96	3.42
	40	2,76	14	1.50	2.95	3.40
	50	3,45	15	1.70	2.91	3.36
180°	20	1,38	11	1.60	2.55	2.94
	30	2,07	12	1.80	2.41	2.78
	40	2,76	13	2.20	2.51	2.89
	50	3,45	14	2.40	2.36	2.72
270°	20	1,38	11	1.90	2.02	2.33
	30	2,07	12	2.40	2.14	2.47
	40	2,76	12	2.60	2.32	2.68
	50	3,45	13	3.20	2.43	2.81
360°	20	1,38	11	2.80	2.23	2.57
	30	2,07	12	3.10	2.07	2.39
	40	2,76	12	3.50	2.34	2.70
	50	3,45	13	3.90	2.22	2.56

Performance Data – Metric

KV12 12' (3,7 m) Nozzle (Brown)

ARC DEGREE	PRESSURE		RADIUS METERS	FLOW L/M	PRECIP mm/hr	
	BAR	PSI			■	▲
90°	1,38	20	3,7	4,16	75	86
	2,07	30	4,0	4,92	75	87
	2,76	40	4,3	5,68	75	86
	3,45	50	4,6	6,44	74	85
180°	1,38	20	3,4	6,06	65	75
	2,07	30	3,7	6,81	61	70
	2,76	40	4,0	8,33	64	73
	3,45	50	4,3	9,08	60	69
270°	1,38	20	3,4	7,19	51	59
	2,07	30	3,7	9,08	54	63
	2,76	40	3,7	9,84	59	68
	3,45	50	4,0	12,11	62	71
360°	1,38	20	3,4	10,60	56	65
	2,07	30	3,7	11,73	53	61
	2,76	40	3,7	13,25	59	69
	3,45	50	4,0	14,76	56	65

*Data represents test results in zero wind. Radius may be reduced with the radius reduction screw.
Bold = recommended pressure of 30 PSI.

Performance Data - U.S.

KV15 15' (4,6 m) Nozzle (Black)

ARC DEGREE	PRESSURE		RADIUS		FLOW		PRECIP in/hr	
	PSI	FEET	GPM	■	▲			
90°	20	15	1.30	2.22	2.57			
	30	17	1.60	2.13	2.46			
	40	18	1.80	2.14	2.47			
	50	19	2.00	2.13	2.46			
180°	20	14	1.80	1.77	2.04			
	30	15	2.30	1.97	2.27			
	40	16	2.60	1.96	2.26			
	50	18	2.80	1.66	1.92			
270°	20	14	2.70	1.77	2.04			
	30	15	3.20	1.83	2.11			
	40	16	3.60	1.80	2.08			
	50	18	4.00	1.58	1.83			
360°	20	14	3.40	1.67	1.93			
	30	15	4.20	1.80	2.07			
	40	16	4.70	1.77	2.04			
	50	16	5.30	1.99	2.30			

Performance Data - Metric

KV15 15' (4,6 m) Nozzle (Black)

ARC DEGREE	PRESSURE		RADIUS		FLOW		PRECIP mm/hr	
	BAR	METERS	L/M	■	▲			
90°	1,38	4,6	4,92	56	65			
	2,07	5,2	6,06	54	62			
	2,76	5,5	6,81	54	63			
	3,45	5,8	7,57	54	62			
180°	1,38	4,3	6,81	45	52			
	2,07	4,6	8,71	50	58			
	2,76	4,9	9,84	50	57			
	3,45	5,5	10,60	42	49			
270°	1,38	4,3	10,22	45	52			
	2,07	4,6	12,11	46	53			
	2,76	4,9	13,63	46	53			
	3,45	5,5	15,14	40	46			
360°	1,38	4,3	12,87	42	49			
	2,07	4,6	15,90	46	53			
	2,76	4,9	17,79	45	52			
	3,45	4,9	20,06	51	58			

Performance Data - U.S.

KV17 17' (5,2 m) Nozzle (Gray)

ARC DEGREE	PRESSURE		RADIUS		FLOW		PRECIP in/hr	
	PSI	FEET	GPM	■	▲			
90°	20	18	1.70	2.02	2.33			
	30	18	1.80	2.14	2.47			
	40	19	2.00	2.13	2.46			
	50	20	2.20	2.12	2.45			
180°	20	17	1.90	1.27	1.46			
	30	18	2.40	1.43	1.65			
	40	19	2.60	1.39	1.60			
	50	19	2.90	1.55	1.79			
270°	20	16	2.90	1.45	1.68			
	30	17	3.40	1.51	1.74			
	40	18	4.00	1.58	1.83			
	50	18	4.50	1.78	2.06			
360°	20	15	3.50	1.50	1.73			
	30	17	4.40	1.47	1.69			
	40	17	4.90	1.63	1.88			
	50	18	5.40	1.60	1.85			

Performance Data - Metric

KV17 17' (5,2 m) Nozzle (Gray)

ARC DEGREE	PRESSURE		RADIUS		FLOW		PRECIP mm/hr	
	BAR	METERS	L/M	■	▲			
90°	1,38	5,5	6,44	51	59			
	2,07	5,5	6,81	54	63			
	2,76	5,8	7,57	54	62			
	3,45	6,1	8,33	54	62			
180°	1,38	5,2	7,19	32	37			
	2,07	5,5	9,08	36	42			
	2,76	5,8	9,84	35	41			
	3,45	5,8	10,98	39	45			
270°	1,38	4,9	10,98	37	43			
	2,07	5,2	12,87	38	44			
	2,76	5,5	15,14	40	46			
	3,45	5,5	17,03	45	52			
360°	1,38	4,6	13,25	38	44			
	2,07	5,2	16,66	37	43			
	2,76	5,2	18,55	41	48			
	3,45	5,5	20,44	41	47			

*Data represents test results in zero wind. Radius may be reduced with the radius reduction screw.
Bold = recommended pressure of 30 PSI.



Fixed Pattern Nozzles

Male-threaded, female-threaded, and special patterns for system flexibility.

Features

- Four distances plus eight fixed patterns provide an array of system configurations
- Color-coded for easy identification
- Recommended Operating Pressure – 30 PSI (2,1 bar)

Models

FN-8

8' (2,4 m) Female Nozzle
■ Green

FN-10

10' (3,0 m) Female Nozzle
■ Blue

FN-12

12' (3,7 m) Female Nozzle
■ Brown

FN-15

15' (4,6 m) Female Nozzle
■ Black

FN-15CS

Center Strip, Female

FN-15ES

End Strip, Female

FN-15SS

Side Strip, Female

FN-15HL

High Low, Female

P12

12' (3,7 M) Male Nozzle
■ Brown

P15

15' (4,6 m) Male Nozzle
■ Black

P15CS

Center Strip, Male

P15ES

End Strip, Male

P15SS

Side Strip, Male

P15HL

High Low, Male

Performance Data – U.S.

FN-8 8' (2,4 m) Nozzle, Female (Green)

ARC DEGREE	PRESSURE		RADIUS FEET	FLOW GPM	PRECIP in/hr	
	PSI	FEET			■	▲
90° FN-8Q	20	6	0.21	2.25	2.59	
	25	7	0.24	1.89	2.18	
	30	8	0.26	1.56	1.81	
180° FN-8H	20	6	0.42	2.25	2.59	
	25	7	0.47	1.85	2.13	
	30	8	0.52	1.56	1.81	
270° FN-8TQ	20	6	0.63	2.25	2.59	
	25	7	0.71	1.86	2.15	
	30	8	0.78	1.56	1.81	
360° FN-8F	20	6	0.86	2.30	2.66	
	25	7	0.96	1.89	2.18	
	30	8	1.05	1.58	1.82	

Performance Data – U.S.

FN-10 10' (3 m) Nozzle, Female (Blue)

ARC DEGREE	PRESSURE		RADIUS FEET	FLOW GPM	PRECIP in/hr	
	PSI	FEET			■	▲
90° FN-10Q	20	8	0.33	1.99	2.29	
	25	9	0.36	1.71	1.98	
	30	10	0.39	1.50	1.73	
180° FN-10H	20	8	0.65	1.96	2.26	
	25	9	0.72	1.71	1.98	
	30	10	0.79	1.52	1.76	
270° FN-10TQ	20	8	0.98	1.97	2.27	
	25	9	1.08	1.71	1.98	
	30	10	1.18	1.51	1.75	
360° FN-10F	20	8	1.03	1.55	1.79	
	25	9	1.44	1.71	1.98	
	30	10	1.58	1.52	1.76	

Performance Data – U.S.

FN-12 12' (3,7 m) Nozzle, Female (Brown)

ARC DEGREE	PRESSURE		RADIUS FEET	FLOW GPM	PRECIP in/hr	
	PSI	FEET			■	▲
90° FN-12Q	20	10	0.53	2.04	2.36	
	25	11	0.60	1.91	2.20	
	30	12	0.65	1.74	2.01	
180° FN-12H	20	10	1.05	2.02	2.33	
	25	11	1.20	1.91	2.20	
	30	12	1.30	1.74	2.01	
270° FN-12TQ	20	10	1.58	2.03	2.34	
	25	11	1.80	1.91	2.20	
	30	12	1.95	1.74	2.01	
360° FN-12F	20	10	2.10	2.02	2.33	
	25	12	2.40	1.91	2.20	
	30	12	2.60	1.74	2.01	

Performance Data – U.S.

FN-15 15' (4,6 m) Nozzle, Female (Black)

ARC DEGREE	PRESSURE		RADIUS FEET	FLOW GPM	PRECIP in/hr	
	PSI	FEET			■	▲
90° FN-15Q	20	12	0.75	2.01	2.32	
	25	14	0.82	1.61	1.86	
	30	15	0.92	1.57	1.82	
180° FN-15H	20	12	1.50	2.01	2.32	
	25	14	1.65	1.62	1.87	
	30	15	1.85	1.58	1.83	
270° FN-15TQ	20	12	2.25	2.01	2.32	
	25	14	2.48	1.62	1.88	
	30	15	2.78	1.59	1.83	
360° FN-15F	20	12	3.00	2.01	2.32	
	25	14	3.30	1.62	1.87	
	30	15	3.70	1.58	1.83	

Performance Data – Metric

FN-8 8' (2,4 m) Nozzle, Female (Green)

ARC DEGREE	PRESSURE		RADIUS METERS	FLOW L/M	PRECIP mm/hr	
	BAR	METERS			■	▲
90° FN-8Q	1,4	1,8	0,80	57	66	
	1,7	2,1	0,90	48	55	
	2,1	2,4	1,00	40	46	
180° FN-8H	1,4	1,8	1,60	57	66	
	1,7	2,1	1,80	47	54	
	2,1	2,4	2,00	40	46	
270° FN-8TQ	1,4	1,8	2,40	57	66	
	1,7	2,1	2,70	47	54	
	2,1	2,4	3,00	40	46	
360° FN-8F	1,4	1,8	3,30	58	67	
	1,7	2,1	3,60	48	55	
	2,1	2,4	4,00	40	46	

Performance Data – Metric

FN-10 10' (3 m) Nozzle, Female (Blue)

ARC DEGREE	PRESSURE		RADIUS METERS	FLOW L/M	PRECIP mm/hr	
	BAR	METERS			■	▲
90° FN-10Q	1,4	2,4	1,20	50	58	
	1,7	2,7	1,40	43	50	
	2,1	3,1	1,50	38	44	
180° FN-10H	1,4	2,4	2,50	50	57	
	1,7	2,7	2,70	43	50	
	2,1	3,1	3,00	39	45	
270° FN-10TQ	1,4	2,4	3,70	50	58	
	1,7	2,7	4,10	43	50	
	2,1	3,1	4,50	38	44	
360° FN-10F	1,4	2,4	3,90	39	45	
	1,7	2,7	5,50	43	50	
	2,1	3,1	6,00	39	45	

Performance Data – Metric

FN-12 12' (3,7 m) Nozzle, Female (Brown)

ARC DEGREE	PRESSURE		RADIUS METERS	FLOW L/M	PRECIP mm/hr	
	BAR	METERS			■	▲
90° FN-12Q	1,4	3,1	1,51	52	60	
	1,7	3,4	1,70	48	56	
	2,1	3,7	2,27	44	51	
180° FN-12H	1,4	3,1	2,27	51	59	
	1,7	3,4	3,03	48	56	
	2,1	3,7	3,79	44	51	
270° FN-12TQ	1,4	3,1	3,60	51	59	
	1,7	3,4	3,79	48	56	
	2,1	3,7	4,92	44	51	
360° FN-12F	1,4	3,1	6,06	51	59	
	1,7	3,4	6,81	48	56	
	2,1	3,7	7,95	44	51	

Performance Data – Metric

FN-15 15' (4,6 m) Nozzle, Female (Black)

ARC DEGREE	PRESSURE		RADIUS METERS	FLOW L/M	PRECIP mm/hr	
	BAR	METERS			■	▲
90° FN-15Q	1,4	3,7	2,80	51	59	
	1,7	4,3	3,10	41	47	
	2,1	4,6	3,50	40	46	
180° FN-15H	1,4	3,7	5,70	51	59	
	1,7	4,3	6,20	41	47	
	2,1	4,6	7,00	40	46	
270° FN-15TQ	1,4	3,7	8,50	51	59	
	1,7	4,3	9,40	41	48	
	2,1	4,6	10,50	40	46	
360° FN-15F	1,4	3,7	11,40	51	59	
	1,7	4,3	12,50	41	47	
	2,1	4,6	14,00	40	46	

*Data represents test results in zero wind. Radius may be reduced with the radius reduction screw.
Bold = recommended pressure of 30 PSI.

Performance Data – U.S.

PI2 12' (3,7 m) Nozzle, Male (Brown)

ARC DEGREE	PRESSURE		RADIUS	FLOW	PRECIP in/hr			
	PSI	FEET			■	▲		
90° PI2Q	20	11	11	0.40	1.27	1.47		
	25	12					1.20	1.39
	30	13					1.14	1.32
	40	14					1.18	1.36
180° PI2H	20	11	11	0.80	1.27	1.47		
	25	12					1.20	1.39
	30	13					1.14	1.32
	40	14					1.18	1.36
270° PI2TQ	20	11	11	1.20	1.27	1.47		
	25	12					1.35	1.39
	30	13					1.50	1.14
	40	14					1.80	1.18
360° PI2F	20	11	11	1.60	1.27	1.47		
	25	12					1.80	1.39
	30	13					2.00	1.14
	40	14					2.40	1.18

Performance Data – Metric

PI2 12' (3,7 m) Nozzle, Male (Brown)

ARC DEGREE	PRESSURE		RADIUS	FLOW	PRECIP mm/hr			
	BAR	METERS			■	▲		
90° PI2Q	1,4	3,4	3,4	1,5	32	37		
	1,7	3,7					31	35
	2,1	4,3					29	33
	2,8	4,6					30	35
180° PI2H	1,4	3,4	3,4	3,0	32	37		
	1,7	3,7					34	35
	2,1	4,3					3,8	29
	2,8	4,6					4,6	30
270° PI2TQ	1,4	3,4	3,4	4,5	32	37		
	1,7	3,7					5,1	30
	2,1	4,3					5,7	29
	2,8	4,6					6,9	30
360° PI2F	1,4	3,4	3,4	6,1	32	37		
	1,7	3,7					6,8	31
	2,1	4,3					7,6	29
	2,8	4,6					9,1	30

Performance Data – U.S.

PI5 15' (4,6 m) Nozzle, Male (Black)

ARC DEGREE	PRESSURE		RADIUS	FLOW	PRECIP in/hr			
	PSI	FEET			■	▲		
90° PI5Q	20	13	13	0.60	1.37	1.58		
	25	14					0.75	1.47
	30	16					0.90	1.35
	40	17					1.10	1.47
180° PI5H	20	13	13	1.20	1.37	1.58		
	25	14					1.50	1.47
	30	16					1.80	1.35
	40	17					2.20	1.47
270° PI5TQ	20	13	13	1.80	1.36	1.57		
	25	14					2.25	1.47
	30	16					2.70	1.35
	40	17					3.30	1.46
360° PI5F	20	13	13	2.40	1.37	1.58		
	25	14					3.00	1.47
	30	16					3.60	1.35
	40	17					4.40	1.47

Performance Data – Metric

PI5 15' (4,6 m) Nozzle, Male (Black)

ARC DEGREE	PRESSURE		RADIUS	FLOW	PRECIP mm/hr			
	BAR	METERS			■	▲		
90° PI5Q	1,4	4,0	4,0	2,3	35	40		
	1,7	4,3					2,8	37
	2,1	4,9					3,4	34
	2,8	5,2					4,2	37
180° PI5H	1,4	4,0	4,0	4,5	35	40		
	1,7	4,3					5,7	37
	2,8	4,9					6,8	34
	3,4	5,2					8,3	37
270° PI5TQ	1,4	3,4	3,4	6,8	35	40		
	1,7	4,3					8,5	37
	2,1	4,9					10,2	34
	2,8	5,2					12,5	37
360° PI5F	1,4	3,4	3,4	9,1	35	40		
	1,7	4,3					11,4	37
	2,8	4,9					13,6	34
	3,4	5,2					16,7	37

Performance Data – U.S.

Special Patterns

NOZZLE PATTERN	NOZZLE		PRESSURE	W X L		FLOW
	Male #	Female#		PSI	Feet	
Center Strip	PI5CS FN-15cs		20	4 x 24	0.8	
			30	4 x 30	1.0	
End Strip	PI5ES FN-15Es		20	4 x 12	0.4	
			30	4 x 15	0.5	
Side Strip	PI5SS FN-15SS		20	4 x 28	1.1	
			30	5 x 32	1.3	
High Strip			20	High: 14 x 28	2.5	
			30	Low: 4 x 28	3.0	
			30	High: 15 x 32		

Performance Data – Metric

Special Patterns

NOZZLE PATTERN	NOZZLE		PRESSURE	W X L		FLOW
	Male #	Female#		BAR	Meters	
Center Strip	PI5CS FN-15cs		1,5	1,2 x 7,3	3,0	
			2,0	1,2 x 9,1	3,8	
End Strip	PI5ES FN-15Es		1,5	1,2 x 3,7	1,5	
			2,0	1,2 x 4,6	1,9	
Side Strip	PI5SS FN-15SS		1,5	1,2 x 8,5	4,2	
			2,0	1,5 x 9,8	4,9	
High Strip			1,5	High: 4,3 x 8,5	9,5	
			2,0	Low: 1,2 x 8,5	11,4	
			2,0	High: 4,6 x 9,8		



*Data represents test results in zero wind. Radius may be reduced with the radius reduction screw.
Bold = recommended pressure of 30 PSI.

Bubblers

Pressure compensating bubblers are ideal for non-turf areas.

Features

- Pressure compensation ensures consistent flow rates over different pressures
- Pressure compensating bubblers are ideal for tree and large shrub watering

Specifications

- Operating Pressure: 20 – 50 PSI (1,4 – 3,5 bar)
- Spacing: 1' – 3' (0,3 m – 0,9 m)
- Umbrella Pattern

Models

TB-025 0.25 GPM (0,95 LPM) Bubbler, Pressure Compensating

TB-05 0.5 GPM (1,9 LPM) Bubbler, Pressure Compensating

TB-10 1.0 GPM (3,8 LPM) Bubbler, Pressure Compensating

TB-20 2.0 GPM (7,6 LPM) Bubbler, Pressure Compensating

TB-ADJ Adjustable Bubbler

Fast Facts

ALL	INLET: 1/2" (1,3 CM) FEMALE THREAD
TB-025	Flow Rate: 0.25 GPM (0,06 m ³ /h; 0,95 l/m)
TB-05	Flow Rate: 0.5 GPM (0,114 m ³ /h; 1,9 l/m)
TB-10	Flow Rate: 1.0 GPM (0,227 m ³ /h; 3,8 l/m)
TB-20	Flow Rate: 2.0 GPM (0,454 m ³ /h; 7,6 l/m)
TB-ADJ	Flow Rate: 0.1 – 4.5 GPM (0,31 – 1,34 m ³ /h; 5 – 22 l/m)



Drip Irrigation

Efficient and trouble-free operation for non-turf areas.

Features

- Install Above or Below Grade

Dripline:

- ▶ Pressure-compensating Emitters – Ensure uniform output across the entire length of run
- ▶ In-line Emitter Check Valves – Prevents drainage from the dripline when water pressure drops below 2.5 PSI, protecting against the siphoning of small sediment and soil particles into the drip emitter – ideal for sub-surface installation
- ▶ Available in Two Flow Rates and 2 spacing sizes – Provides maximum design flexibility in a variety of applications

- ▶ Drip Control Zone Kit – Pre-assembled for quick installation, heavy duty, corrosion resistant, 150 mesh stainless steel filter

Specifications

- Flow rates: .58 GPH (2,3 L/H) color code - orange, 1 GPH (3,8 L/H) color code - gray
- Operating pressure: 12 – 50 PSI (0,8 – 3,5 bar)
- Check valve sealing pressure: 2.5 PSI (0,17 bar)
- Check valve opening pressure: 4.3 PSI (0,3 bar)
- Dripline color: brown
- Size: 1/2" (0.57" ID x 0.67" OD) (14,5 mm ID x 17 mm OD)
- Spacing: 12" or 18" (30,5 cm or 45,7 cm)
- Minimum bending radius: 1' (0,3 m)
- Filter requirement: minimum of 150 mesh

DRIP CONTROL ZONE KIT

- Pressure regulation 30 or 40 PSI (2,1 or 2,8 bar)
- Flow: 1 – 35 GPM (1,9 – 94,6 LPM)
- Operating pressure: 10 – 120 PSI (0,7 – 8,3 bar)
- Solenoid: 24V AC
- Inlet: 1" (2,5 cm) female thread NPT
- Outlet: 1" (2,5 cm) female thread NPT
- Dimensions: Height: 6 1/2" (16,5 cm), Width: 3" (7,6 cm), Length: 14 1/2" (36,8 cm)

Models

KA5-112P-CV	0.67" (17 mm) 0.58 GPH (2,2 LPH), 100' (30,5 m) CV drip line coil w/12" (0,30 m) spacing, 0.57" ID x 0.67" OD (14,5 mm ID x 17 mm OD), brown
KA5-212P-CV	0.67" (17 mm) 0.58 GPH (2,2 LPH), 250' (76,2 m) CV drip line coil w/12" (0,30 m) spacing, 0.57" ID x 0.67" OD (14,5 mm ID x 17 mm OD), brown
KA5-512P-CV	0.67" (17 mm) 0.58 GPH (2,2 LPH), 500' (152,4 m) CV drip line coil w/12" (0,30 m) spacing, 0.57" ID x 0.67" OD (14,5 mm ID x 17 mm OD), brown
KA5-2112P-CV	0.67" (17 mm) 1.00 GPH (3,8 LPH), 100' (30,5 m) CV drip line coil w/ 12" (0,30 m) spacing, 0.57" ID x 0.67" OD (14,5 mm ID x 17 mm OD), brown
KA5-2212P-CV	.67" (17 mm) 1.00 GPH (3,8 LPH), 250' (76,2 m) CV drip line coil w/ 12" (0,30 m) spacing, 0.57" ID x .67" OD (14,5 mm ID x 17 mm OD), brown
KA5-2512P-CV	0.67" (17 mm) 1.00 GPH (3,8 LPH), 500' (152,4 m)
KA1-118P-CV	0.67" (17 mm) 1 GPH (3,8 LPH), 100' (30,5 m)
KA1-218P-CV	.67" (17 mm) 1 GPH (3,8 LPH), 250' (76,2 m) CV drip line coil w/18" (0,45 m) spacing, 0.57" ID x 0.67" OD (14,5 mm ID x 17 mm OD), brown
KA1-518P-CV	0.67" (17 mm) 1.00 GPH (3,8 LPH), 500' (152,4 m) CV drip line coil w/ 18" (0,45 m) spacing, .57" ID x .67" OD (14,5 mm ID x 17 mm OD), brown
K15-040	0.67" (17 mm) barb coupling
K15-041	0.67" (17 mm) tee
K15-042	0.67" (17 mm) elbow
K15-043	0.67" (17 mm) barb x 1/2" (1,27 cm) NPT Tee
K15-046	0.67" (17 mm) barb x 1/2" (1,27 cm) NPT Adapter
K18-028	1/2" (1,27 cm) Air/Vacuum Relief Valve
KP11-155	3/4" (1,9 cm) plastic filter with 155 m stainless steel screen & flush cap
KP11-374	1" (2,5 cm) plastic LP 1 Y-filter stainless steel screen 150 mesh
KPR30YFI	Pressure regulated Y filter NPT, 30 PSI, 1", Low Flow
KPR30YFI-BSP	Pressure regulated Y filter BSP, 30 PSI, 1", Low Flow
KPR40YFI	Pressure regulated Y filter NPT, 40 PSI, 1", Low Flow
KPR40YFI-BSP	Pressure regulated Y filter BSP, 40 PSI, 1", Low Flow
KP7001-FPR30INT-KIT	Drip control zone kit NPT, 1", with 30 PSI pressure regulated Y filter
KP7001-FPR40INT-KIT	Drip control zone kit NPT, 1", with 40 PSI pressure regulated Y filter
KP7001-BSP-FPR30INT-KIT	Drip control zone kit BSP 1", 30 PSI pressure regulated Y filter
KP7001-BSP-FPR40INT-KIT	Drip control zone kit BSP 1", 40 PSI pressure regulated Y filter



Drip control zone kit with pressure regulator and filter

NEW

VALVES



Valve | Comparison Chart

Versatile and heavy-duty, ProSeries valves deliver long life and reliable performance. Offering a wide array of features and benefits, the K-Rain® line is manufactured with the highest standards and provides exceptional functionality.

Item Number	ProSeries 100		ProSeries 150			ProSeries 200		
	7075	7001	7101	7115	7102	7201	7215	7202
Specifications								
Size	3/4"	1"	1"	1 1/2"	2"	1"	1 1/2"	2"
Flow range (GPM)	1-20	5-30	5-30	20-80	20-120	5-30	20-100	20-150
Pressure range (PSI)	20-150	20-150	10-150	20-150	20-150	6-200	6-200	6-200
Features								
Flow control	optional	optional	optional	●	●	●	●	●
Tilt diaphragm/ piston assembly	●	●						
Manual external bleed screw	●	●	●	●	●			
Manual operation with solenoid	●	●	●	●	●	●	●	●
Self-cleaning metering screen	●	●						
Removable metering pin			●	●	●			
Angle/Globe Option			●	●	●			
Glass-filled nylon construction and reinforced rubber diaphragm						●	●	●
Warranty	7 years	7 years	7 years	7 years	7 years	7 years	7 years	7 years

ProSeries 100 Valves

A straight-through flow pattern reduces the risk of trapped debris.

Features

- Heavy Duty, Corrosion and UV Resistant PVC Construction – Increases the life of the valve
- Tilt Diaphragm/Piston Assembly – Allows for a straight flow path of water, increasing the flow rate while reducing friction loss
- Debris Tolerant Design – Offers flexibility for use in potable or non-potable applications
- Manual External Bleed Screw – Provides for manual operation in system start up and easy valve maintenance
- Flow Control with Removable Handle – Delivers precise flow adjustment to the zone and allows you to remove the handle to prevent tampering (Except NFC)
- Self Cleaning Screen – Screen is in flow path of water for self-cleaning action during operation

Electrical Specifications

- Standard Solenoid: 24V AC 60 Hz
- Inrush Current: .43 Amps
- Holding Current: .25 Amps

Accessories

See page 61

Fast Facts

7075 (3/4")	Height:	4" (10,2 cm)
Models	Width:	3" (7,6 cm)
	Length:	4 1/2" (11,4 cm)
7001 (1")	Height:	4" (10,2 cm)
Models	Width:	3" (7,6 cm)
	Length:	5 1/4" (13,3 cm)

Operating Specifications

U.S.			Metric		
Pressure Loss in PSI			Pressure Loss in bar		
FLOW GPM	3/4"	1"	FLOW LPM	3/4"	1"
1	4.0		4	0,28	
5	5.0	2.2	19	0,34	0,15
10	6.0	3.0	38	0,41	0,21
15	11.0	3.5	57	0,76	0,24
20	14.0	4.0	76	0,97	,28
30		5.0	114		0,34
Pressure Range			Pressure Range		
	3/4"	1"		3/4"	1"
	20 - 150 PSI			1,4 - 10,3 bar	



Models

7075	3/4" Female NPT Thread
7075-NFC	3/4" Female NPT Thread, No Flow Control
7075-SL	3/4" Female Slip
7075-SL-NFC	3/4" Female Slip, No Flow Control
7075-BSP	3/4" Female BSP Thread
7075-BSP-NFC	3/4" Female BSP Thread, No Flow Control
7001	1" Female NPT Thread x Female NPT Thread
7001-SL	1" Female Slip
7001-BSP	1" Female BSP Thread
7001-NFC	1" Female NPT Thread No Flow Control
7001-SL-NFC	1" Female Slip, No Flow Control

7001-BSP-NFC	1" Female BSP Thread, No Flow Control
7001-MXB	1" Male NPT Thread x 1" Male Barb
7001-MXM	1" Male NPT Thread x 1" Male Thread
7001-BSP-MXM	1" Male BSP Thread x 1" Male BSP Thread
7001-MXM-NFC	1" Male NPT Thread x 1" Male Thread, No Flow Control
7001-BSP-MXM-NFC	1" Male BSP Thread x 1" Male BSP Thread, No Flow Control
7001-MXB-NFC	1" Male NPT Thread x 1" Male Barb, No Flow Control

How to Specify 9 Volt solenoid

MODELS	OPTIONS
7001	-9VDC

Examples: 7001-SL-9VDC



TILT DIAPHRAGM/PISTON ASSEMBLY

Allows water to flow straight through, reducing friction loss

DEBRIS-TOLERANT DESIGN

Offers flexibility for use in potable or non-potable applications

SELF-CLEANING DIAPHRAGM SCREEN

Enables automatic removal of debris and sediment during operation



▶ Manual Flow Control

Precisely adjust flow to the zone. Removable handle prevents tampering



▶ Captured Plunger Solenoid

Remove the solenoid without losing the internal plunger

▶ Versatility

These 1" models accept 1" PVC inside or 1 1/4" PVC fitting or bell end pipe outside

- ▶ 7001
- ▶ 7001-BSP
- ▶ 7001-NFC
- ▶ 7001-SL-NFC
- ▶ 7001-BSP-NFC



WATCH VIDEO

ProSeries 150 Valves

Heavy Duty, Corrosion and UV Resistant PVC Construction.

Features

- Manual External Bleed Screw – Provides for manual operation in system start up
- Flow Control Option – For precise flow adjustment
- Removable Metering Pin – easily clean metering pin without disassembling

1-1/2" AND 2" MODELS

- Removable Inlet Cap – Allows for easy conversion from globe to angle-style valve
- Heavy Duty Diaphragm – Unique design improves durability of diaphragm
- Manual Internal Bleed through Solenoid – Provides for manual operation without discharging water outside the valve

JAR-TOP MODELS

- Threaded Jar-Top – Allows for quick removal of the cap for easy servicing after installation
- Glass-Filled Nylon Screw Cap – Increased durability
- Manual Internal Bleed through Solenoid – Provides for manual operation without discharging water outside the valve

Models

7101	1" Female NPT Thread
7101-SL	1" Female Slip
7101-BSP	1" Female BSP Thread
7101-BSP-FC	1" Female BSP Thread, with Flow Control
7101-FC	1" Female NPT Thread, with Flow Control
7101-SL-FC	1" Female Slip with Flow Control
7101-J	1" Female NPT Thread Jar-Top
7101-J-SL	1" Female Slip Jar-Top
7101-J-BSP	1" Female BSP Thread Jar-Top
7101-J-MXB	1" Male NPT Thread x 1" Barb Jar-Top
7101-ANGLE	1" Female NPT Thread
7101-ANGLE-FC	1" Female NPT Thread, with Flow Control
7101-ANGLE-SL	1" Female Slip
7101-ANGLE-SL-FC	1" Female Slip with Flow Control
7101-ANGLE-BSP	1" Female BSP Thread
7101-ANGLE-BSP-FC	1" Female BSP Thread, with Flow Control
7115	1 1/2" Female NPT Thread
7115-BSP	1 1/2" Female BSP Thread
7102	2" Female NPT Thread
7102-BSP	2" Female BSP Thread

How to Specify 9 Volt solenoid

MODELS	OPTIONS
7101	-9VDC

Examples: 7101-SL-9VDC

Accessories See page 61

Fast Facts

7101 (1") Models	Height: 5 1/4" (13,3 cm) Width: 3 1/8" (7,95 cm) Length: 5" (12,7 cm)
7101 (1") with Flow Control	Height: 5 7/8" (14,9 cm) Width: 3 1/8" (7,95 cm) Length: 5" (12,7 cm)
7101 (1") Jar Top Models	Height: 5 1/4" (13,3 cm) Width: 3" (7,6 cm) Length: 4 3/8" (11,1 cm)
7101-Angle (1") Models	Height: 5 1/2" (13,97 cm) Width: 3 1/8" (7,95 cm) Length: 4" (10,6 cm)
7101-Angle-FC (1") with Flow Control	Height: 6 3/4" (17,1 cm) Width: 3 1/8" (7,95 cm) Length: 4" (10,6 cm)
7115 (1.5") Models	Height: 8" (20,3 cm) Width: 4 1/4" (10,8 cm) Length: 5 1/2" (14 cm)
7102 (2") Models	Height: 8 7/8" (22,6 cm) Width: 4 7/8" (12,4 cm) Length: 6 1/3" (16,1 cm)

Manual External Bleed Screw

The 1", 1 1/2" and 2" models feature a removable external bleed screw and metering pin to simplify cleaning and maintenance. With the External Bleed Screw, manual operation during start up is easy.

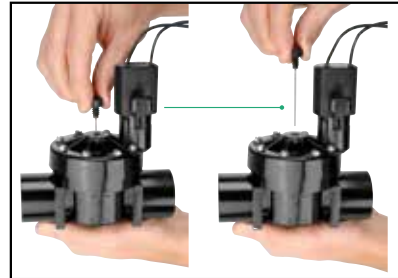

Electrical Specifications

- Standard Solenoid: 24V AC 60 Hz
- Inrush Current: 0.43 Amps
- Holding Current: 0.25 Amps

System Flexibility

Removable inlet cap allows for easy conversion from globe to angle-style valve.





Operating Specifications

U.S.

Pressure Loss in PSI

Flow GPM	1" Globe	1" Jar Top	1" Angle	1 1/2" Globe	1 1/2" Angle	2" Globe	2" Angle
5	2.9	3.3	2.5				
10	2.1	3.9	2.1				
15	1.8	2.9	2.1				
20	3.0	3.2	2.2	3.0	2.7	2.2	1.9
30	5.0	6.1	4.1	2.6	2.2	1.9	1.9
40				2.3	1.9	1.7	1.7
50				2.9	2.2	1.5	1.5
60				4.1	3.0	1.6	1.5
80				5.5	4.4	2.9	2.1
100						4.8	3.2
120						6.2	4.6

Pressure Range

1" Globe	1" Jar Top	1" Angle	1 1/2" Globe	1 1/2" Angle	2" Globe	2" Angle
10-150 PSI			20-150 PSI			

Metric

Pressure Loss in bar

Flow LPM	1" Globe	1" Jar Top	1" Angle	1 1/2" Globe	1 1/2" Angle	2" Globe	2" Angle
18	0,20	0,23	0,17				
38	0,14	0,27	0,14				
57	0,12	0,20	0,14				
76	0,21	0,22	0,15	0,21	0,19	0,15	0,13
114	0,34	0,42	0,28	0,18	0,15	0,13	0,13
151				0,16	0,13	0,12	0,12
189				0,20	0,15	0,10	0,10
227				0,28	0,21	0,11	0,10
303				0,38	0,30	0,20	0,14
379					0,33	0,33	0,22
454					0,43	0,43	0,32

Pressure Range

1" Globe	1" Jar Top	1" Angle	1 1/2" Globe	1 1/2" Angle	2" Globe	2" Angle
0,7-10,3 bar			1,4-10,3 bar			

ProSeries 200 Valves

A durable, high-pressure rated valve engineered for systems up to 200 PSI.

Features

- Durable Glass-filled Nylon Construction and Reinforced Rubber Diaphragm – Ensures long life and reliable performance
- Flow Control – Adjust water flow as needed
- Water Flow Direction Indicator – Ensures proper installation every time
- Electric or Manual Operation

Models

- 7201** 1" Female NPT Thread
7215 1 1/2" Female NPT Thread
7202 2" Female NPT Thread
7203-BSP 3" Female BSP Thread

How to Specify

MODELS	OPTIONS
7201	- 9VDC
7201	- BSP

Examples: 7201-BSP

Electrical Specifications

- Standard solenoid: 24V AC 50/60 Hz
- Inrush current: 0.43 amp
- Holding current: 0.25 amp

Fast Facts

7201 (1") Models	Height: 5 1/4" (13,3 cm) Width: 3 1/8" (7,9 cm) Length: 5 1/8" (13,0 cm)
7201 (1") Jar Top Models	Height: 5 3/4" (14,6 cm) Width: 3 1/8" (8 cm) Length: 4 3/4" (12,0 cm)
7215 (1.5") Models	Height: 6 3/4" (17,2 cm) Width: 4 1/4" (10,8 cm) Length: 6 1/4" (15,9 cm)
7202 (2") Models	Height: 7" (17,8 cm) Width: 4 1/4" (10,8 cm) Length: 7 1/4" (18,4 cm)

Accessories

See page 61

Operating Specifications

FLOW GPM	ProSeries 200 Pressure Loss in PSI - U.S.		
	1" Globe	1 1/2" Globe	2" Globe
5	0.4		
10	1.2		
15	2.5		
20	4.7	2.7	2.9
25	7.3	3	2.5
30	9.7	2.9	2.2
40		2.9	2.2
50		3.4	2.8
60		4.2	3.4
80		7.6	5.5
100		12.9	7.8
120			11.7
150			20

Pressure Range		
1" Globe	1 1/2" Globe	2" Globe
6-200 PSI		

FLOW LPM	ProSeries 200 Pressure Loss in bar - Metric		
	1" Globe	1 1/2" Globe	2" Globe
19	0,03		
38	0,08		
57	0,17		
76	0,32	0,19	0,20
95	0,50	0,21	0,18
114	0,67	0,20	0,15
151		0,20	0,15
189		0,24	0,19
227		0,29	0,23
303		0,52	0,38
379		0,89	0,54
454			0,80
568			1,38

Pressure Range		
1" Globe	1 1/2" Globe	2" Globe
0,4-13,8 bar		



Models

SOLENOIDS AND ADAPTERS

- P3008113** 24V AC Solenoid
- P3008114** 9V DC Latching Solenoid
- P3004750** Replacement K-Rain® Kit: 24V solenoid with Rain Bird® & Hunter® adapters (1 each)
- P3004758** Replacement K-Rain® Kit: 9V solenoid with Rain Bird® & Hunter® adapters (1 each)
- P3004760** Rain Bird® & Hunter® adapter for K-Rain® 24V or 9V solenoid (1 ea)
- P3004770** K-Rain® 24V or 9V solenoid adapters for Rain Bird® (5 pack)
- P3004780** K-Rain® 24V or 9V solenoid adapters for Hunter® (5 pack)
- P3004810** 24V Solenoid, 1 Signature Adapter
- P3004815** 9V Solenoid, 1 Signature Adapter
- P3004820** 5 pack Signature Adapters



VALVE BOXES

- VB60** K-Rain® Round Valve Box 6" (Box Black, Lid Green)
- VB101** K-Rain® Round Valve Box 10" (Box Green, Lid Green)
- VB121** K-Rain® Valve Box 12"x 17"x 12" (Box Green, Lid Green)
- VB121-X** K-Rain® Valve Extension 12"x 17"x 6" (Box Green, Lid Green)
- VB151** K-Rain® Valve Box 15"x 21"x 12" (Box Green, Lid Green)
- VB151-X** K-Rain® Valve Extension 15"x 21"x 6" (Box Green, Lid Green)
- VB103-RCW** K-Rain® Round Valve Box 10" (Box Purple, Lid Purple)
- VB123-RCW** K-Rain® Valve Box 12"x 17"x 12" (Box Purple, Lid Purple)
- VB123-X-RCW** K-Rain® Valve Extension 15"x 21"x 6" (Box Purple, Lid Purple)
- VB153-RCW** K-Rain® RCW - Valve Box Extension 12"x 17"x 6" (Box Purple, Lid Purple)
- VB153-X-RCW** K-Rain® Valve Extension 15"x 21"x 6" (Box Purple, Lid Purple)

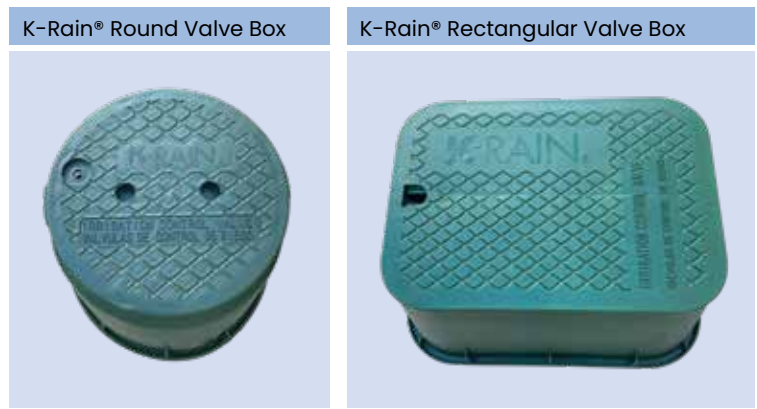

CONTROLLERS



Controller | Comparison Chart

K-Rain® offers a full range of controllers to meet the needs of any irrigation project. From conventional to Wi-Fi, Bluetooth, or the most advanced 2-wire decoder controller, K-Rain® controllers are recognized as feature-packed yet easy to program.

	SiteMaster	PRO-EX3	PRO EX 2.0	PRO-LC	BLUE-LTE	K-Rain® BLUE®	RPS™46
Controller Type	2-Wire Decoder	Hybrid Modular + 2-Wire	Modular Wi-Fi Ready	Conventional Wi-Fi Ready	BT + LTE + Solar	Bluetooth Battery	Mini
Specifications							
Stations/zones	1 to 99	40	Up to 28	4, 8, 12	4	1, 2, 4	4, 6
Programs	6	6	3	3, 6*	3	6	4
Start times per program	6	6	4	4	8	8	4
Features							
Hand-held remote control compatible			●			smart device	
App controlled		with Wi-Fi option	with Wi-Fi option	with Wi-Fi option	●	●	
Wi-Fi capability		●	optional	optional			
Full program display	●	●	●	●	In app	In app	
Backlit display	●	●	●				
Seasonal adjust	●	●	●	●	●	●	●
Buried valve locator		●	●	●			
Flow sensor ready	●	●	●				
Rain/freeze sensor ready	●	●	●	●	●	●	●
Weather station ready	●	with Wi-Fi option	with Wi-Fi option	with Wi-Fi option			
Permanent memory	●	●	●	●	●	●	
Max number of stations running simultaneously	12	4	1	1	1	1	1
Station delay	●	●	●	●			
Pump/MV programmable	Up to 5	●	●	●			●
Geo-locate function					●	●	
Battery Backup	●	●	●	●	●	●	●
Customizable	●	●	●	●			
Warranty	3 years	3 years	3 years	3 years	3 years	3 years	3 years

*When Bridge WiFi added

SiteMaster

2-Wire decoder controller.



ACCESSORIES



3401
Single Station
Decoder



3401-2
Two Station
Decoder



3402
Surge
Protector



3403
2-WIRE MODULE



3404
Network Module



Available in
Stainless Steel
Cases

Expandable up to 99 ZONES

- **Patented Full-Program Display:** View all 99 zones on a single screen, including watering days, start times, stations, and special programming—no scrolling or guessing.
- **Dual Transformer Design:** Isolates the midbox from the two-wire output for added safety while maximizing power across the entire wire path.
- **Independent Wire Paths:** Two separate paths (two lines per path) simplify troubleshooting and allow one side of the system to operate even if the other is down.
- **Advanced Diagnostics:** Features an interactive fault log and real-time decoder signal strength and status.
- **Rain and Freeze Sensor Ready:** compatible with standard weather-sensing accessories.
- **Flexible Programming:** Six independent programs, each with up to six start times.
- **Full On-Screen Keyboard:** Simplifies naming and programming for faster setup.

Specifications

OPERATING SPECIFICATIONS

- Station Run Times: 1 second to 9:59:59 Programs A, B, C, D, E, & F
- Start Times: 6 per program
- Watering Schedule: 7 Day Calendar (any day of the week), odd/even days, interval watering up to 31 days
- Operating Temperature: 0°–140° F (18°–60° C)
- Zone Capacity: 99 zones
- Zone Groups - Up to 12 zones per group (A and B total)
- Pump Start Requirements: Pump Starts wired directly to the controller require a K-Rain® 1520 or 1510 mini coil power relay. Remote pump start relays on the 2-wire path require the K-Rain® 3410 Optical Pump Start Relay in conjunction with a K-Rain® 1520 or 1510 mini coil power relay

ELECTRICAL SPECIFICATIONS

- 2-Wire transformer; Input: 120/240 50/60 Hz
Max Output: 27V AC 100VA 3.7 AMP
- Control Panel Transformer; Input: 120/240 50/60 Hz
Max Output: 24V AC 40VA 1.71 AMP
- Battery: 2032 Coin Cell (included)
9V alkaline battery (optional, not included)

Fast Facts

3400	Height: 11.91" (30,3 cm) Width: 15 1/2" (39,2 cm) Depth: 6 1/2" (16,33 cm)
3420	Height: 16" (41,0 cm) Width: 18 1/2" (47,0 cm) Depth: 9 1/4" (23,5 cm)
3421	Height: 38" (96,5 cm) Width: 16 1/2" (41,9 cm) Depth: 17 1/4" (43,8 cm)

Models

- 3400** 110V AC 2-wire decoder controller
- 3400-220** 220V AC 2-wire decoder controller
- 3420** 110V AC 2-wire decoder controller in stainless steel cabinet
- 3420-220** 220V AC 2-wire decoder controller in stainless steel cabinet
- 3421** 110V AC 2-wire decoder controller on stainless steel pedestal
- 3421-220** 220V AC 2-wire decoder controller on stainless steel pedestal

Accessories

See page 77

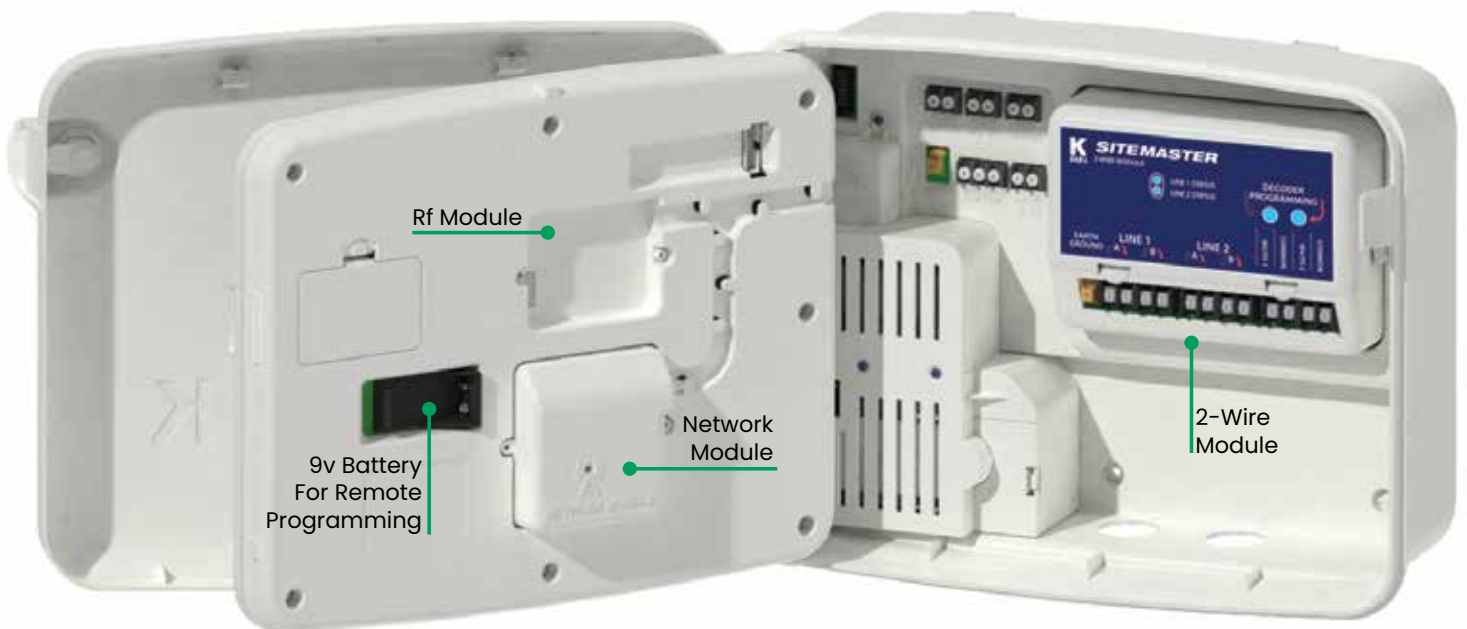

WATCH VIDEO

BEST IN THE INDUSTRY
WARRANTY
3 YEARS

PRO-EX3

HYBRID ▶ *Modular + 2-Wire*

NEW



PRO-EX3
HYBRID ▶ Modular + 2-Wire

BEST IN THE INDUSTRY
WARRANTY
3 YEARS



3100-BRIDGE
Wi-Fi Module

ACCESSORIES



3322
2-WIRE MODULE



3304
4 STATION
Module



3308
8 STATION
Module



3311
SINGLE STATION DECODER

Expandable up to 40 STATIONS



HYBRID ♦
Modular + 2 Wire with
RapidAssign™ Decoder Pairing



Full Program
Backlit Display



6 Programs
6 Start Times Per Program
Up to 6 Hour Run Times



Smart Wi-Fi:
With Water Management
Capabilities



Adaptive
Irrigation
Mode



Buried Valve
Locator

Features

- Hybrid Irrigation Controller – Supports both conventional wiring modules (4- or 8-station) and 2-wire decoder technology
- Maximum 40 stations: 4 conventional base stations + up to 24 conventional stations (3 × 8-station modules) or up to 36 two-wire stations
- Smart Wi-Fi Capable – Add K-Rain Wi-Fi Bridge (3100-Bridge) for remote control and monitoring via smartphone, tablet, or web browser
- New AIM (Adaptive Irrigation Mode) – Advanced smart weather-based watering system with adjustable limits that automatically optimizes irrigation when equipped with Wi-Fi
- Patented Full Program Display – One screen shows watering days, number of start times, number of stations and special programming
- Flow Sensor and Rain Sensor or Rain/Freeze Sensor ready
- Diagnostic Circuit Breaker – Identifies and isolates stations/valves with wiring problems (shorts, faults) while the rest of the program continues
- Station Delay/Overlap Programming – Adjustable delay between stations or simultaneous operation for well recovery, slow-closing valves and water hammer prevention
- 2 Hard wired MV/PS terminals as well as 1 Remote MV/PS on the 2-wire system
- Permanent Memory – Non-volatile memory preserves programs during power outages
- Master Valve/Pump Start Ready – Programmable per station as needed
- Advanced Features: Looping Functionality, Cycle and Soak, Zone Grouping (Up to 4 stations plus a master valve), and Seasonal Adjust – Global adjustment from 10–200% in 10% increments, Permanent Day Off – Set any day of the week as a non-watering day regardless of programming
- Built-in Level – Ensures easy, accurate leveling during installation
- Robust enclosure design for maximum durability

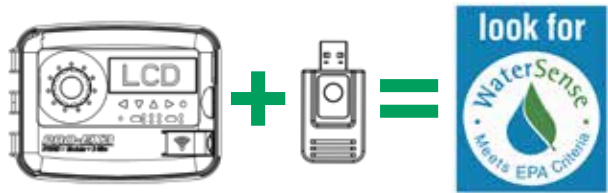

Fast Facts

Height:	8" (20,3 cm)
Width:	10 1/2" (26,7 cm)
Depth:	5 1/4" (13,3 cm)

Specifications

OPERATING SPECIFICATIONS

- Station Run Times: 1 minute to 6 hours for all stations
- Number of Programs: 6 (A–F)
- Number of Automatic Start Times: 6 per program
- Program Watering Schedules: Custom (day of the week), Interval (1–31 days), Odd (odd calendar days), Even (even calendar days)

ELECTRICAL SPECIFICATIONS

- Power Input: 110V AC 60Hz, 240V AC, 50/60Hz
- Power Output: 24V AC 2A
- Power Backup: Lithium coin-cell battery maintains time and date

Models

- **3302 Pro-EX3 110V** PRO-EX3 4-Station modular controller, 110V AC internal transformer with pigtail
- **3302-220 Pro-EX3 220V** PRO-EX3 4-Station modular controller, 220V AC internal transformer with pigtail

PRO-EX3 Specific Accessories

- **3304** Pro-EX3 4 Station Module
- **3308** Pro-EX3 8 Station Module
- **3311** Pro-EX3 Single Station Decoder
- **3322** Pro-EX3 2 Wire Module

Accessories See page 77



WATCH VIDEO



DOWNLOAD APP

PRO EX 2.0

Modular Irrigation Controller.



Wi-Fi kit



220V AC plug pack
(International use)



WATCH VIDEO



DOWNLOAD APP
IOS



DOWNLOAD APP
ANDROID

BEST IN THE INDUSTRY
WARRANTY
3 YEARS

Expandable up to 28 STATIONS



Multiple Modular
Combinations
Up to 28 Stations



Full Program
Backlit Display



3 Programs
4 Start Times Per Program
Up to 6 Hour Run Times



Smart Wi-Fi:
With Water Management
Capabilities



FlowLogic™ Intelligent
Water Flow Monitoring
and Protection



Buried Valve
Locator

Features

- Wi-Fi capable – Syncs with Wi-Fi to allow functionality through a smartphone, tablet or web browser. Weather IQ with adjustable limits. Remote access and alerts*
- Expandable up to 28 stations. Add hot-swappable 4 and 14 station expansion modules and run 4, 8, 12, 14, 16, 18, 22 or 28 stations
- Patented Full Program Display – One screen shows watering days, number of start times, number of stations and special programming
- Flow Sensor Ready – Connects directly. Has high/low flow abort settings and provides flow data capture up to 7 days on device and full history on web browser when configured as a Wi-Fi controller
- Rain sensor and rain/freeze sensor ready
- RF Module Connector – Allows for optional installation of wireless accessories: Handheld remote, wireless rain sensor and Wi-Fi hub
- Diagnostic Circuit Breaker – Identifies and isolates stations with valve or wiring problems (shorts, faults, valve location) while remaining program continues
- Station Delay/Overlap Programming – Additional time between stations or dual operation for issues like well recovery, slow closing valves and water hammer
- Large Backlit LCD Screen – Best in class visualization for all installations
- Permanent Memory – Non-volatile memory saves program during power outages
- Removable Mid-Box – Can be programmed while disconnected from enclosure
- Buried Valve Locate Feature – Helps locate buried valves in field
- Master Valve/Pump Start Ready – Programming for individual station(s) operation as needed
- Permanent Day Off – Set any day of the week, regardless of programming, as a non-watering day
- Seasonal Adjust – Quick, easy global adjustment of watering times from 10–200% conserves water
- Built-in Level – Makes leveling the unit easy during install

Fast Facts

Height:	7 3/4" (19,6 cm)
Width:	10" (25,4 cm)
Depth:	5" (12,7 cm)

Accessories See page 77

Specifications

OPERATING SPECIFICATIONS

- Station Run Times: 1 second to 6 hours for all stations
- Number of Programs: 3
- Number of Automatic Start Times: 4 per program
- Program Watering Schedules:
 - Custom Day of the week
 - Interval 1-31 days
 - Odd Odd calendar days
 - Even Even calendar days

ELECTRICAL SPECIFICATIONS

- Power Input: 110V AC, 50/60Hz, 240V AC, 50/60Hz
- Power Output: 24V AC 1.25Amp – Outdoor
24V AC 1.0Amp – Indoor
- Power Backup:
 - Lithium coin-cell battery maintains time and date
 - 4 AAA batteries allow for mid-box programming

Models

INDOOR MODELS

3202ID	PRO EX 2.0 4 station indoor modular controller, 110V AC plug pack transformer
3202ID-220	PRO EX 2.0 4 station indoor modular controller, 220V AC plug pack transformer
3202ID- WiFi-KIT	PRO EX 2.0 Wi-Fi enabled 4 station indoor modular controller, Wi-Fi hub, RF module, 110V AC plug pack transformer.
3202ID-220-WiFi-KIT	PRO EX 2.0 Wi-Fi enabled 4 station indoor modular controller, Wi-Fi hub, RF module, 220V AC plug pack transformer (International only)

OUTDOOR MODELS

3202	PRO EX 2.0 4 station outdoor modular controller, 110V AC internal transformer
3202-P	PRO EX 2.0 4 station indoor modular controller, with pigtail power cord, 110V AC internal transformer
3202-220	PRO EX 2.0, 4 station outdoor modular controller, 220V AC internal transformer
3202-WiFi-KIT	PRO EX 2.0 Wi-Fi enabled 4 station outdoor modular controller, Wi-Fi hub, RF module
3202-P- WiFi-KIT	PRO EX 2.0 Wi-Fi enabled 4 station outdoor modular controller, with pigtail power cord, Wi-Fi hub, RF module
	PRO EX 2.0 Wi-Fi enabled 4 station outdoor modular controller, Wi-Fi hub, RF module, 220V AC plug pack transformer

PRO-LC

Feature-packed, user friendly, and a Wi-Fi-Capable controller.



Features



Full Program Display:
Large, easy-to-read screen simplifies setup and diagnostics



Contractor Tools: Manage Unlimited Controllers with One Account



Up to 6 Programs
4 Start Times Per Program
Up to 6 Hour Run Times



Buried Valve Locator



Smart Wi-Fi Capable:
Access the K-Rain App with Adaptive Irrigation Mode (AIM) and Water Management Capabilities

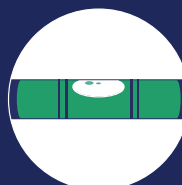

Built-In Bubble Level

Features

- Number of stations: 4, 8, or 12
- Patented full program display feature shows days, start times, number of stations and special programming
- Easy to follow programming
- Large LCD display
- Wi-Fi requires the BRIDGE Wi-Fi Module, sold separately
- Rain sensor and rain/freeze sensor ready
- Seasonal Adjust – Quick, easy global adjustment of watering times from 10–200% conserves water
- Buried valve locator
- Built-in Level – Makes leveling the unit easy

Models

OUTDOOR MODELS

3104W	4 station, 110V AC internal transformer
3104W-220	4 station, 220V AC internal transformer
3108W	8 station, 110V AC internal transformer
3108W-220	8 station, 220V AC internal transformer
3112W	12 station, 110V AC internal transformer
3112W-220	12 station, 220V AC internal transformer

INDOOR MODELS

3104WID-220	4 station, 220V AC plug pack transformer
3108WID-220	8 station, 220V AC plug pack transformer
3112WID-220	12 station, 220V AC plug pack transformer

ACCESSORIES

3100-BRIDGE BRIDGE Wi-Fi Module

Fast Facts

Height:	7" (17,8 cm)
Width:	7" (17,8 cm)
Depth:	3 1/2" (8,9 cm)

Specifications

OPERATING SPECIFICATIONS

- Station Run Times: 1 minute to 6 hours
- Number of Programs: 3 (6 with Wi-Fi)
- Number of Automatic Start Times: 4 per program
- Program Watering Schedules:
 - Odd > Odd calendar days
 - Even > Even calendar days
 - Custom > Day of the week
 - Interval > 1-31 days

ELECTRICAL SPECIFICATIONS

- Power Input:
 - 110V AC, 60Hz
 - 240V AC, 50Hz
- Power Output:
 - 24V AC 1.0Amp
- Power Backup: Lithium coin-cell battery maintains time and date during primary power outages



220V AC plug pack
(International use)

Accessories See page 77



DOWNLOAD APP
IOS



DOWNLOAD APP
ANDROID

WATCH VIDEOS



Basic manual
programming



Advanced
manual
programming



Wi-Fi Irrigation
Controller setup
for homeowners



Wi-Fi Irrigation
controller setup
for contractors

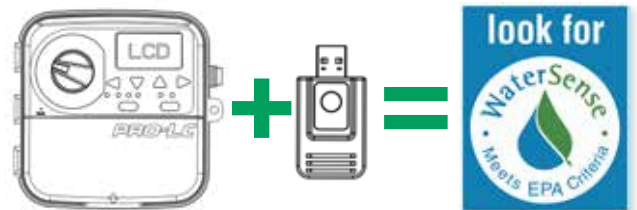

— BEST IN THE INDUSTRY —
WARRANTY
3 YEARS

BLUE-LTE

Modernize your city's irrigation system without trenching, wiring, or guesswork.

NEW



FEATURES

- **Cellular Connectivity** – No Wi-Fi or wired infrastructure required
- **Cloud-Based Dashboard** – Real-time control and scheduling from any device
- **Expandable** – Add units across your city as needed
- **Fail-Safe Design** – Local backup schedule in case of connectivity loss

Fast Facts

Height:	14" (35,6 cm)
Width:	11" (27,9 cm)
Depth:	6 1/2" (16,5 cm)

Specifications

OPERATING SPECIFICATIONS

- 4 stations
- 6 programs, 8 start times per program
- Bluetooth range; 35' (10 m)

ELECTRICAL SPECIFICATIONS

- Works with 9V DC latching solenoids
- Maximum distance between the timer and solenoid is 150' (45,7 m) with 18 AWG (.05" or 1,55 mm²)

Models

BLUE-LTE 4 Station Irrigation Controller

Accessories See page 77

Features and Applications

- ▶ **9V 4-Zone DC Latching Solenoid Controller:** Operates via secure 4G LTE cellular connectivity, perfect for remote sites without AC power—modernize any irrigation system
- ▶ **Fully Off-Grid:** Integrated cellular, with solar panel and internal battery, No Wi-Fi or wired infrastructure required
- ▶ **Weatherproof Enclosure:** Designed for long-term durability in harsh outdoor environments
- ▶ **Remote Management:** Monitor and control one or multiple controllers from any location
- ▶ **Grouping Capability:** Create custom controller groups for fast, centralized management

Median Strips



Parks



Athletic Fields



Community Gardens



Remote Sites



Bluetooth battery powered controller.

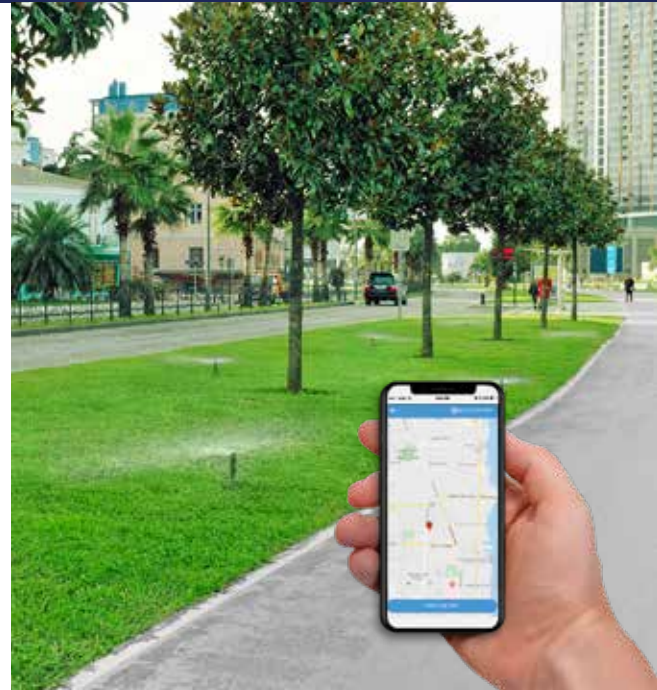

Features

- Number of stations: 1, 2, and 4
- Ideal for areas where AC power is unavailable
- Change controller settings via smartphone, tablet or web browser
- Manage hundreds of controllers from one easy app
- Map feature – see every controller on a map
- CrewView™ feature allows program visibility anywhere
- Battery replacement indicator
- Rain sensor and rain/freeze sensor ready – Allows automated operation to be controlled by sensor
- IP68 certified fully waterproof enclosure installs right in the valve box
- Molded out of UV resistant, high impact ABS resin
- Ideal for isolated/remote valve boxes where running power is expensive or difficult
- Full virtual back up – back up program information & preferences to the cloud
- Water Budget – Quick, easy, global adjustment of watering times from 10-200% conserves water
- Manually start, stop or suspend your controller(s) from up to 35' away
- Add a passcode lock to each controller for added security

Fast Facts

Height:	2 1/8" (5,5 cm)
Width:	5 1/2" (14 cm)
Depth:	3 1/2" (9 cm)

Specifications

OPERATING SPECIFICATIONS

- 4 stations
- 6 programs, 8 start times per program
- Bluetooth range; 35' (10 m)

ELECTRICAL SPECIFICATIONS

- Works with 9V DC latching solenoids
- Maximum distance between the timer and solenoid is 150' (45,7 m) with 18 AWG (.05" or 1,55 mm²)

Models

BLUE-1	1 Station
BLUE-2	2 Station
BLUE-4	4 Station

Accessories See page 77



RPS™ 46

The easiest to use mini irrigation controller.

Features

- 4 & 6 Station Models – Perfect for residential lawn applications
- 4 Fully Independent Programs – Allowing up to 4 starts per program. Maximum 16 starts per day
- Seasonal Adjust – Quick, easy, global adjustment of watering times from 10–200% conserves water
- Heavy Duty 1.0 Amp Transformer
- Rain sensor and rain/freeze sensor ready
- Flexible Manual Operation – Run a program, run a station, or test system
- Battery Back-Up – Saves program during power outages
- Indoor Models with External Transformer & Plug

Specifications

OPERATING SPECIFICATIONS

- Station Run Times: 1 min. to 12 hrs. 59 min.
- Number of Programs: 4
- Number of Automatic Start Times: 4 per program
- Program Watering Schedules: 7 day calendar with individual day selection, 1 to 15 day interval, or ODD/EVEN day watering
- Master Valve/pump start terminal

ELECTRICAL SPECIFICATIONS

- Power Input: 110V AC, 50/60Hz, 240V AC, 50/60Hz
- Power Output: 24V AC, 1.0 AMP
- To Solenoid Valve: 24V AC, 0.5 AMPS max
- Overload protection: Standard 20mm 1.0 AMP fuse
- Power Failure: 9 Volt standard alkaline battery



220V AC plug pack
(International use)

Fast Facts

Height:	5 3/4" (14,5 cm)
Width:	4 1/2" (11,43 cm)
Depth:	1 3/4" (4,3 cm)



Models

- 3504** 4 Station, 110V Plug Pack Transformer
- 3504-220** 4 Station, 220V Plug Pack Transformer
- 3506** 6 Station, 110V Plug Pack Transformer
- 3506-220** 6 Station, 220V Plug Pack Transformer (International use)

Accessories See page 77

Turn your irrigation controller into an expert water manager.

Features

UNIVERSAL RAIN SENSOR RECEIVER

- Flexibility - Allows a K-Rain® Wireless Rain/Freeze Sensor to be paired with any manufacturer's rain sensor terminal equipped controller
- Simplicity - Provides the advantage of extremely quick, easy installation and programming, along with simple pairing with a K-Rain® Rain Sensor
- Weather Resistant - Engineered with impact modified, UV resistant polymer for outdoor exposure
- Maintenance Free - No batteries to replace

RAIN/FREEZE SENSORS

- K-Rain® Rain Sensor products efficiently suspend watering during rain and/or freeze periods
- The K-Rain® wireless rain-freeze sensor can be paired with multiple K-Rain®PRO EX 2.0 Wi-Fi enabled controllers within range, providing an additional value for the end user. The wired rain sensors work with closed circuit timers.
- 2 in 1 Mounting. Provides flexible installation with standard flat & gutter mounting.
- Models 3208-WRFS and 3208-HRFS include a freeze sensor that prevents the irrigation system from starting when temperatures drop to 37°F or below



Controller Compatability

MODELS	PRO-LC	PRO-EX 2.0	PRO-EX3
3208-HRS	●	●	●
3208-HRFS	●	●	●
3208-WRFS		●	
3208-WRFS-KIT		●	
3208-UWRFS	●	●	●

Models

- 3208-HRS** Hardwired Rain Sensor
- 3208-HRFS** Hardwired Rain-Freeze Sensor
- 3208-WRFS** Wireless Rain/Freeze Sensor for PRO EX 2.0 or PRO EX 2.0 Wi-Fi
- 3208-WRFS-KIT** Wireless Rain/Freeze Sensor and RF Module for PRO EX 2.0
- 3208-UWRFS** Universal Wireless Rain/Freeze Sensor



PRO-TAP 100

One-Outlet Hose Faucet Timer

NEW



Features

- Conserve Water - Automate your watering routine
- Oversized Features - Designed with a large digital display and an easy-to-use dial
- One Start Time - Program your timer to water at the optimal time when evaporation is at its lowest
- Timed Watering - Set your timer from 1-360 minutes (6 hrs)
- Watering Intervals - Water frequencies can be set to every 1-12 hours or every 1-7 days
- Manual Rain Delay - Ability to manually postpone watering between 1-7 days without interrupting your set program
- Manual Watering - Run water manually, between 1-360 minutes, with the press of a button
- Easy Attachment - The swivel coupling provides a quick and secure connection to your hose or faucet
- Battery Operated - Requires two AA batteries (not included)
- Product Specifications - For outdoor use with cold water only - Store indoors during winter time

Technical Specifications

Connection	3/4 inch hose
Watering duration	1 min - 6 hrs
Watering Schedule	1-8 hrs, 12 hrs, 1-7 days
Operating Pressure	10-100 PSI / 1-6 Bar
Rain Delay	Yes
Manual Watering	Yes
Environment Temp	0-140°F / 0-60°C
Water Temp	0-140°F / 0-60°C
Batteries	2 AA (not Included)

Models

PRO-TAP100	Tap, Irrigation Controller, STD
PRO-TAP100-BSP2	Tap, Irrigation Controller, BSP

Fast Facts

Height:	5 1/2" (14,0 cm)
Width:	4 3/4" (12,1 cm)
Depth:	2 3/4" (7,0 cm)

BEST IN THE INDUSTRY
WARRANTY
3 YEARS



Replaceable Mesh Filter



Fits 3/4" Standard Hose



Controller Accessories



		SiteMaster	PRO-EX3	PRO EX 2.0	PRO-LC	BLUE-LTE	K-Rain® BLUE®	RPS™46
Accessories								
3100-BRIDGE	Bridge Wi-Fi Module				●			
3203	Handheld Remote with batteries			●				
3203-KIT	Handheld Remote with antenna & RF module			●				
3205	4 Station Expansion Module			●				
3205-14	14 Station Expansion Module			●				
3206	RF module with short distance antenna			●				
3208-HRS	Hardwired Rain Sensor	●		●	●	●	●	●
3208-HRFS	Hardwired Rain/Freeze Sensor	●		●	●	●	●	●
3208-WRFS	Wireless Rain/Freeze Sensor			●				
3208-UWRFS	Universal Wireless Rain/Freeze Sensor	●		●	●			●
3209	Wi-Fi Hub			●				
3304	Pro-EX3 4 Station Module		●					
3308	Pro-EX3 8 Station Module		●					
3311	Pro-EX3 Single Station Decoder		●					
3322	Pro-EX3 2 Wire Module		●					
3401	Single Station Decoder	●						
3401-2	Two Station Decoder	●						
3402	Surge Protector	●						
3403	2-Wire Module	●						
3404	Network Module	●						
3410	Optical Pump Start Relay	●						
3414	Pro Weather Station	●						
FS228-15	1.5" Flow Sensor Assembly	●		●				
FS228-20	2" Flow Sensor Assembly	●		●				
FS228-30	3" Flow Sensor Assembly	●		●				
FS228-40	4" Flow Sensor Assembly	●		●				
FS735-10	1" Flow Sensor Assembly	●		●				

Pump Start Relays

Commercial grade pump start relays in secure rain-tight enclosures are easy to install and simple to use.

Features

- The Pump Start Relay enclosure is constructed with a corrosion resistant, UV resistant, shockproof material

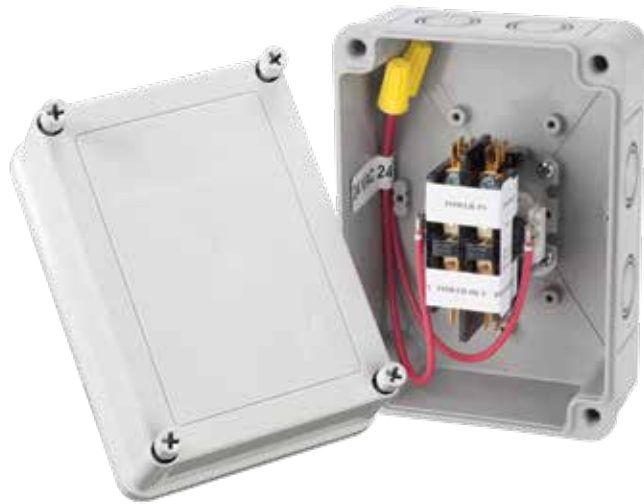

Models

- | | |
|--|---|
| <p>1510 Coil Specifications
120V AC, 60 Hz
Inrush: 35 VA
Sealed: 7.0 VA
Resistance ($\pm 10\%$):
237 OHMS
Mini Coil
24V AC, 50/60 Hz
Inrush: 52 mA</p> | <p>Double Pole, Single Throw
Inductive: 20 AMP
Resistive: 30 AMP
Input: 120V AC - up to 2 H.P.

Sealed: 1.2 VA
Resistance ($\pm 10\%$): 155 OHMS</p> |
| <p>1520 Coil Specifications
240V AC, 60 Hz
Inrush: 35 VA
Sealed: 7.0 VA
Resistance ($\pm 10\%$):
946 OHMS
Mini Coil
24V AC, 50/60 Hz
Inrush: 52 mA</p> | <p>Double Pole, Single Throw
Inductive: 20 AMP
Resistive: 30 AMP
Input: 240V AC - up to 3 H.P.

Sealed: 1.2 VA
Resistance ($\pm 10\%$): 155 OHMS</p> |
| <p>1521 Coil Specifications
120V AC, 60 Hz
Inrush: 42 VA
Sealed: 8.5 VA, 3.6 Watts
Resistance ($\pm 10\%$):
239.3 OHMS</p> | <p>Double Pole, Single Throw
Inductive: 20 AMP
Resistive: 30 AMP
Input: 120V AC - up to 3 H.P.
240V AC - up to 3 H.P.</p> |
| <p>1522 Coil Specifications
24V AC, 60 Hz
Inrush: 35 VA
Sealed: 7 VA, 3 Watts
Resistance ($\pm 10\%$):
11.5 OHMS</p> | <p>Double Pole, Single Throw
Inductive: 20 AMP
Resistive: 30 AMP
Input: 120V AC - up to 3 H.P.
240V AC - up to 3 H.P.</p> |
| <p>1551 Coil Specifications
120V AC, 60 Hz
Inrush: 77 VA
Sealed: 10 VA, 4 Watts
Resistance ($\pm 10\%$):
248.3 OHMS</p> | <p>Double Pole, Single Throw
Inductive: 40 AMP
Resistive: 50 AMP
Input: 120V AC - up to 3 H.P.
240V AC - up to 5 H.P.</p> |
| <p>1552 Coil Specifications
24V AC, 60 Hz
Inrush: 35 VA
Sealed: 7 VA, 2.3 Watts
Resistance ($\pm 10\%$):
11.5 OHMS</p> | <p>Double Pole, Single Throw
Inductive: 40 AMP
Resistive: 50 AMP
Input: 120V AC - up to 3 H.P.
240V AC - up to 5 H.P.</p> |
| <p>1553 Coil Specifications
24V AC, 60 Hz
Inrush: 60 VA
Sealed: 7 VA, 2.7 Watts
Resistance ($\pm 10\%$):
7 OHMS</p> | <p>THREE PHASE OPERATION
Triple Pole, Single Throw
Inductive: 40 AMP
Resistive: 50 AMP
Input: 120V AC - up to 3 H.P.
240V AC - up to 10 H.P.</p> |

Single Station Controllers



Time-tested reliable single station controllers in rain-tight enclosures.

Features

2100 MODELS

- 24 hour programmable time dial
- Multiple start times
- Wide variety of timing periods
- "Skip-A-Day" 14 day program

2200 MODELS

- Perfect for nursery and other mist applications
- 10 minute programmable dial
- Wide variety of timing periods
- Multiple start times

2500 MODELS

- Prewired for easy connection of a rain sensor. Manual override switch on the faceplate.



Models

2100 SINGLE STATION CONTROLLERS

2110	Voltage Input: 110V AC, 60 Hz Output: 110V AC, 60 Hz	Rating Single Pole, Single Throw Relay Rated for up to 1 H.P.
2112	Voltage Input: 110V AC, 60 Hz Output: 110V AC, 60 Hz	Rating Double Pole, Single Throw Relay Rated for up to 2 H.P.
2114	Voltage Input: 110V AC, 60 Hz Output: 24V AC, 30 VA	Rating Built-In Transformer
2120	Voltage Input: 220V AC, 60 Hz Output: 220V AC, 60 Hz	Rating Double Pole, Single Throw Relay Rated for up to 2 H.P.
2124	Voltage Input: 220V AC, 60 Hz Output: 24V AC, 20 VA	Rating Built-In Transformer

2200 SHORT DURATION SINGLE STATION CONTROLLERS

2210	Voltage Input: 110V AC, 60 Hz Output: 110V AC, 60 Hz	Rating Relay Rated for up to 1 H.P.
2214	Voltage Input: 110V AC, 60 Hz Output: 24V AC, 30 VA	Rating Built-In Transformer

2500 RAINSWITCH-READY CONTROLLERS

2510	Voltage Input: 110V AC, 60 Hz Output: 110V AC, 60 Hz	Rating Double Pole, Single Throw Relay Rated for up to 2 H.P.
2514	Voltage Input: 110V AC, 60 Hz Output: 24V AC, 30 VA	Rating Built-In Transformer
2520	Voltage Input: 220V AC, 60 Hz Output: 220V AC, 60 Hz	Rating Double Pole, Single Throw Relay Rated for up to 2 H.P.

4000 Series Indexing Valves

A reliable, economical way to automate multiple zoned residential and small commercial irrigation systems.

Features

- ABS Polymer Construction – High-strength, non-corrosive body for long product life
- Available in 4 and 6 Outlet Models – Can quickly and easily change from two to six watering zones
- Simplicity of Design – Valves are easily maintained and serviced for long product life
- Operates as low as 10 GPM (38 LPM) flow rate at Pressures of 25-75 PSI (1,7-5,2 bar) – Reliably automates multiple zoned residential and small commercial irrigation or wastewater systems

Models

FOUR OUTLET MODELS

- 4400** No Cam
4402 Cammed for 2 Zone Operation
4403 Cammed for 3 Zone Operation
4404 Cammed for 4 Zone Operation

SIX OUTLET MODELS

- 4600** No Cam
4602 Cammed for 2 Zone Operation
4603 Cammed for 3 Zone Operation
4604 Cammed for 4 Zone Operation
4605 Cammed for 5 Zone Operation
4606 Cammed for 6 Zone Operation

OTHER OPTIONS ADD TO PART NUMBER:

- RCW** Reclaimed Water Use

Accessories*

- P7005507** Stem/disk Assembly Standard (.029-White) 10 GPM** (38 LPM)
P7005509 Stem/disk Assembly Light (.025-Blue) 6 GPM (23 LPM)
P7005511 Stem/disk Assembly Heavy (.032-Red) 15 GPM (57 LPM)
P6107042 Two zone cam for four or six outlet valve
P6107043 Three zone cam for four outlet valve
P6107044 Four zone cam for four outlet valve
P6107063 Three zone cam for six outlet valve
P6107064 Four zone cam for six outlet valve
P6107065 Five zone cam for six outlet valve
P6107066 Six zone cam for six outlet valve

*Color code identified at the bottom of the disk

**Pre-installed

Fast Facts

Height	5 3/4" (14,6 cm)
Width	5 3/4" (14,6 cm)
4 Outlet Models	1 1/4" x 1 1/4" (3,2 cm x 3,2 cm)
6 Outlet Models	1 1/4" x 1" (3,2 cm x 2,5 cm)

Operating Specifications

4 OUTLET VALVE				
Flow Rate, GPM	10	20	30	40
PSI Loss	2	3	4.5	6.4
Pressure Range	25-75 PSI (1,7-5,2 bar)			
Flow Range	10-40 GPM (37,9-151,4 LPM)			
6 OUTLET VALVE				
Flow Rate, GPM	10	20	30	
PSI Loss	2.5	4.5	7.5	
Pressure Range	25-75 PSI (1,7-5,2 bar)			
Flow Range	10-30 GPM (37,9-113,6 LPM)			



6000 Series Indexing Valves

The 6000 line of indexing valves offers exceptional reliability and durability even under the dirtiest water conditions.

Features

- Metal Die-Cast Body – Durable, long lasting and capable of high pressure applications
- Available in 4 and 6 Outlet Models – Can quickly and easily change number of watering zones with a cam change
- Simplicity of Design – Valves are easily maintained & serviced for long product life
- Operates as low as 15 GPM (57 LPM) at Pressures of 25–150 PSI (1,7 to 10,3 bar)– Ideal for pump-fed systems or high-flow city water systems
- Built-in Atmospheric Vacuum Breaker – Releases any vacuum created between the pump and the valve on shut down

Models

FOUR OUTLET MODELS

- 6402** Cammed for 2 Zone Operation
- 6403** Cammed for 3 Zone Operation
- 6404** Cammed for 4 Zone Operation

SIX OUTLET MODELS

- 6605** Cammed for 5 Zone Operation
- 6606** Cammed for 6 Zone Operation

Other options add to part number:

- RCW** Reclaimed Water Use

Accessories*

- P8003050** Stem/disk Assembly Standard Heavy (.032-Red) 15 GPM** (57 LPM)
- P8003051** Stem/disk Assembly Light (.028-White) 10 GPM (38 LPM)
- P8003052** Stem/disk Assembly Extra Light (.025-Blue) 6 GPM (23 LPM)
- P8002902** Two zone, 4 outlet cam
- P8002903** Three zone, 4 outlet cam
- P8002904** Four zone, 4 outlet cam
- P8002905** Five zone, 6 outlet cam
- P8002906** Six zone, 6 outlet cam

*Color code identified at the bottom of the disk

**Pre-installed

Fast Facts

Valve Top/Housing	Die Cast Metal
Valve Outlets	High Strength ABS Polymer
Inlet	Threaded 1 1/2" (3,8 cm) NPT
Outlets	Slip & Glue Connections to 1 1/2" (3,8 cm) PVC Pipe
Height	7" (17,8 cm)
Width	8" (20,3 cm)

Operating Specifications

4 OUTLET VALVE					
Flow Rate, GPM	20	40	60	80	100
PSI Loss	2.5	3.5	5	7.5	10
Pressure Range	25 - 150 PSI (1,7 to 10,3 bar)				
Flow Range	15-150 GPM (57-568 LPM)				

6 OUTLET VALVE					
Flow Rate, GPM	20	40	60	80	100
PSI Loss	3	4	6	9	11
Pressure Range	25 - 150 PSI (1,7 to 10,3 bar)				
Flow Range	15-150 GPM (57-568 LPM)				



Reclaimed Water (RCW) Series

Rotors, Sprays and Indexing Valves for Reclaimed Water.

K-Rain® is a leading manufacturer of rotors, sprays and distribution valves for the reclaimed water industry.

The K-Rain® RCW series is designed specifically for use on reclaimed water systems. Flexibility in system design, achieved through a wide selection of nozzles, guarantees matched precipitation.

Features

RCW ROTORS

- Heavy Duty Rubber Cover (purple) – Seals out dirt and increases product durability, positively identifies the use of reclaimed water reducing liability. Not available on MiniPro® or RPS™50.
- Accepts Low Angle Nozzle – Ensures the correct trajectory of reclaimed water – Not available on MiniPro® or RPS™50
- Glass Filled Nylon Cap – RPS™ Select, SuperPro®, ProPlus®.

RCW SPRAYS

- Purple cap positively identifies the use of reclaimed water reducing liability.
- Heavy-duty retraction spring – Strongest in the industry for complete retraction in all soil conditions.
- Ratcheting Riser – Allows for easy pattern alignment by turning the riser.
- Pre-installed flush cap.
- Accepts female threaded nozzles.

RCW INDEXING VALVES

- Available in 4 and 6 Outlet Models – Watering zones can be changed quickly and easily.
- 4000 RCW Indexing Valve – Automates multiple zoned residential and small commercial wastewater systems.
- 6000 RCW Indexing Valve – Metal die-cast body is capable of high pressure applications.



Models

Please refer to product pages for individual product model numbers and performance data.

PRODUCT	PAGE
MiniPro®	6
RPS™ 50	8
RPS™ 75	9
RPS™ 75i	12
RPS™ Select	16
ProPlus®	18
SuperPro®	20
ProSport®	24
Pro-S™ Spray	30
K-Spray™	33
4000 Series Valves	74
6000 Series Valves	75



4000 Series
Indexing Valves



6000 Series
Indexing Valves

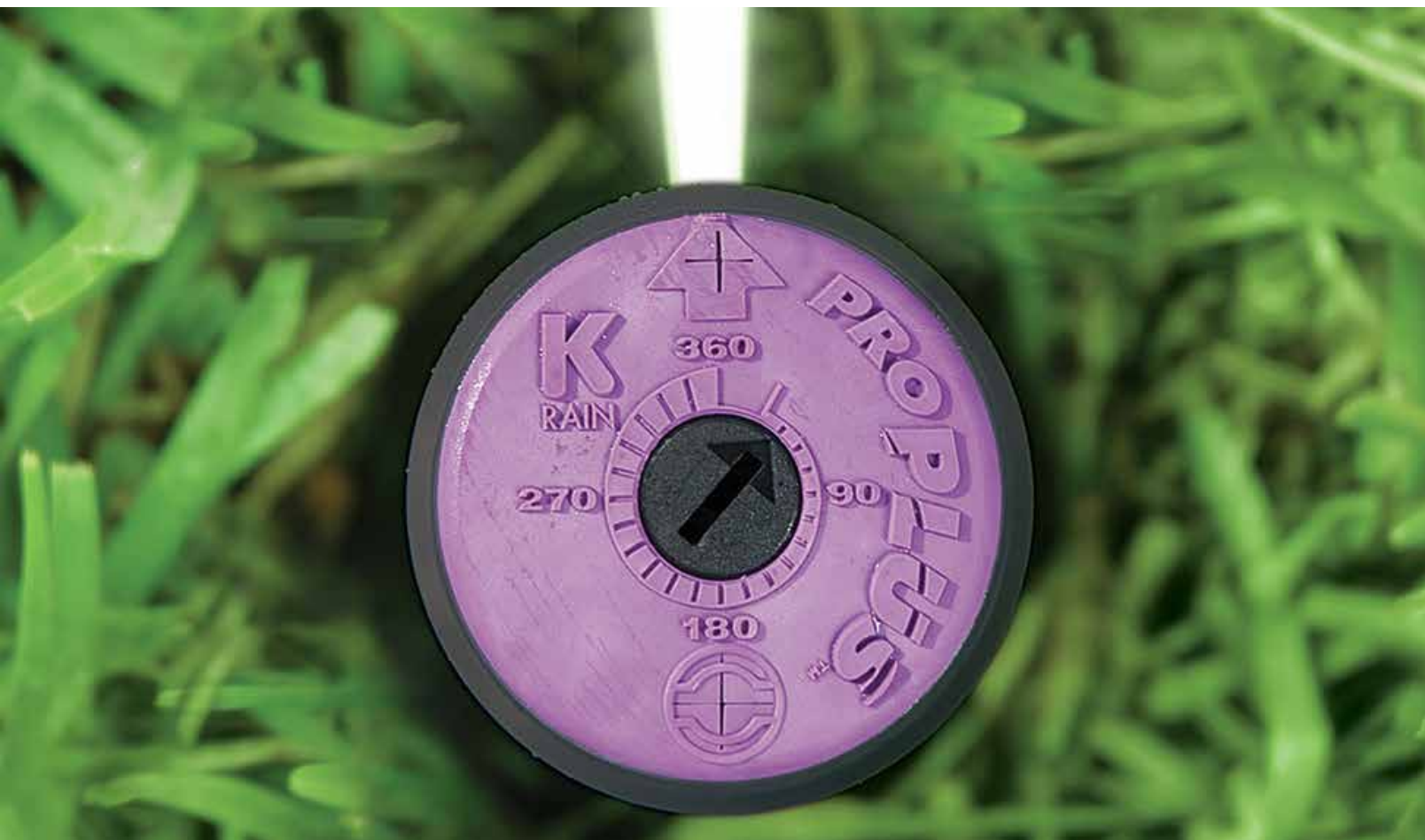

Custom Products

Customizable Irrigation Products

Leave a lasting reminder of your company at each installation.

Add your logo, phone number, and/or website to select rotors, sprays and controllers.

Best part, it's FREE!

When you are enrolled in our Premier Contractor Loyalty Program.



**SuperPro®
Rotor**

Min: 1 pallet
Subsequent purchases:
1/2 pallets



**RPS™ 75 & 75i
Rotors**

Min: 1 pallet
Subsequent purchases:
1/2 pallets



**Pro-S™ Spray
Nozzle Guard**

Min: 1 pallet of Sprays



**Pro-S™ Spray
Twist Cap**

Min: 1 pallet of Sprays



**PRO-LC
Irrigation
Controller**

Min: 1 case



**PRO EX 2.0
Irrigation
Controller**

Min: 1 case



**PRO EX3
Irrigation
Controller**

Min: 1 case



**SITEMASTER
2-Wire Decoder
Controller**

Min: Qty 1

**Give your
business
a shoutout**





Are you getting **CASH BACK** on your K-Rain® Purchases?

As a member of the K-Rain® Premier Contractor Program, you earn cash rewards on all K-Rain® purchases from authorized distributors. You also receive other benefits such as homeowner referrals, free product customization, and training & certification. From the moment you join the program, you start earning rewards.

Your rebate INCREASES each time you reach a new level:



Rewards can be redeemed for:
Distributor Credit, Visa Gift Cards, Online Irrigation Training or irrigation/landscaping software.



To Enroll:
Scan the QR code
or go to premier.krain.com

Design Resources

For irrigation Professionals

The K-Rain® website, www.krain.com, is a resource for product manuals, videos, FAQs, and other valuable information. Additionally our website has guides for designing with and installing K-Rain® products. Whether you are a landscape architect, irrigation designer, or other irrigation professional, K-Rain® has developed libraries to help you quickly find the information you need. Visit the site for CAD detail drawings, irrigation designs for sports fields, and more.

CAD DETAIL DRAWINGS

www.krain.com/CAD-DETAIL-DRAWINGS

Lay out your irrigation design effectively and efficiently. We offer 2 file formats for each part number for your convenience: PDF and DWG

- Irrigation Controllers & Rain Sensor
- Rotors
- Pro-S™ Sprays
- Pro-S™ Sprays with Rotary Nozzles
- Valves

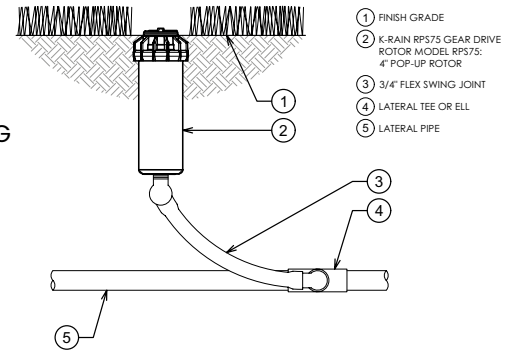

00 K-RAIN RPS75 ROTOR WITH 4" POP-UP
3" = 1'-0"

www.krain.com

IRRIGATION DESIGNS FOR SPORTS FIELDS

WWW.KRAIN.COM/SPORTS-FIELD-DESIGN

Our Sports Field Irrigation Designs contain Irrigation Design Criteria for water source and head layouts. There you will find water pressure and flow requirements along with general head spacing by field type. A graphic scale is provided on each field type.

- Baseball
 - Baseball Field-5 Row
- Football
 - Football Field-4 Row
 - Football Field-5 Row
- Little League Field
 - Little League Field-3 Row
- Soccer
 - Soccer Field-5 Row
 - Soccer Field-6 Row (ProSport)
 - Soccer Field-6 Row (RPS75i)
- Tennis
 - Double Tennis Court-3 Row

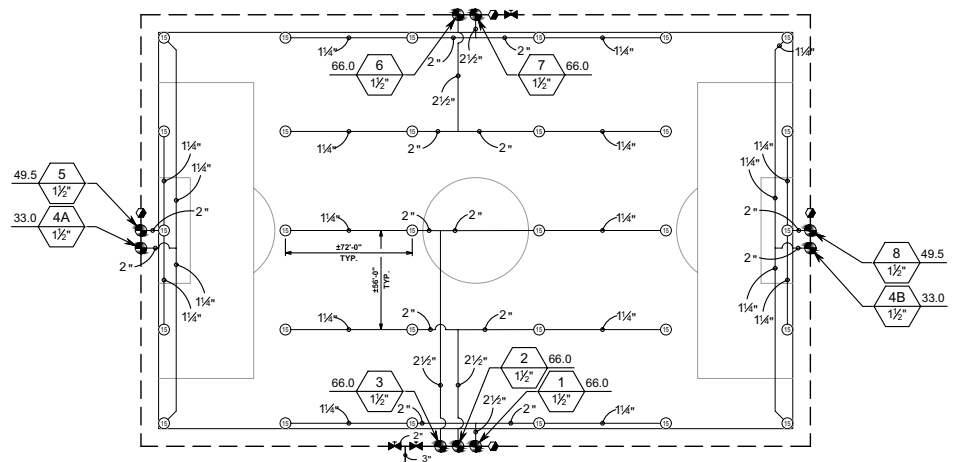
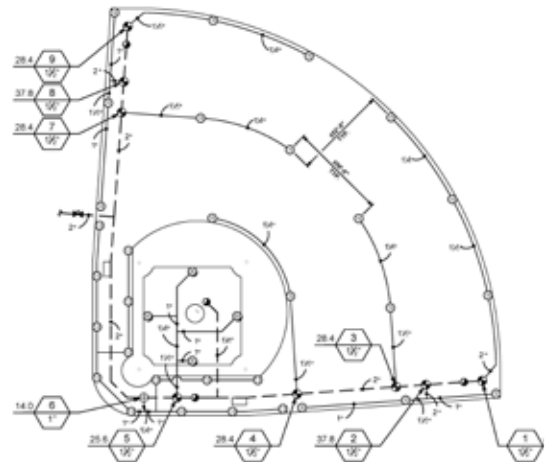

Conversion Table for U.S. and Metric Systems

METRIC TO U.S.				
MULTIPLY		TO OBTAIN		
Millimeters (mm)	x	.03937	=	inches
Centimeters (cm)	x	.3937	=	inches
Meters (m)	x	39.37	=	inches
Meters (m)	x	3.281	=	feet
Meters (m)	x	1.094	=	yards
Kilometers (km)	x	.62137	=	miles
Kilometers (km)	x	1093.62	=	yards
Kilometers (km)	x	3280.87	=	feet
Liters (l)	x	1.0567	=	quarts (liq.)
Liters (l)	x	.2642	=	gallons (U.S.)
Liters (l)	x	.455	=	pounds
Temp. in (C° x 1.80)	+	32°	=	temp. in F°

U.S. TO METRIC				
MULTIPLY		TO OBTAIN		
Inches (in.)	x	25.4	=	millimeters
Inches (in.)	x	2.54	=	centimeters
Inches (in.)	x	.0254	=	meters
Feet (ft.)	x	.3048	=	meters
Yards (yds.)	x	.9144	=	meters
Miles (mi.)	x	1.6093	=	kilometers
Yards (yds.)	x	.0009143	=	kilometers
Feet (ft.)	x	.0003048	=	kilometers
Quarts (qts.)	x	.945	=	liters
Gallons	x	3.78	=	liters
Pounds	x	2.2	=	liters
Temp. in F° - 32°	x	.5666	=	temp. in C°

Kilograms per cubic centimeter (kg/cm²)	x	14.223	=	Pounds per square inch (P.S.I.)
Cubic Foot (cu. ft.) x 28.316			=	Liters (l.)

MISCELLANEOUS CONVERSION FACTORS					
Feet head (ft. hd.) x .433	=	Pounds per square inch (P.S.I.)	Calorie x 3.968	=	British Thermal Unit (B.T.U.)
Pounds per square inch x 2.31	=	Feet head	Foot pounds per second x .7373	=	Watts
Meters x 3.28	=	Feet head	Kilowatts x 1.34	=	Horsepower
Inches of mercury x1.133	=	Feet head	Square foot x 144	=	Square inches
U.S. gallons per minute x .1337	=	Cubic feet per minute	Square yard x 9	=	Square feet
Cubic feet per minute x 7.48	=	U.S. gallons per minute	Acre x 4.840	=	Square yards
British Imperial gallon x 1.201	=	U.S. gallons	Acre x 43,560	=	Square feet
Acre inches per hour x 453	=	G.P.M.	Square mile (section) x 640	=	Acres
Acre foot per day x226	=	G.P.M.	Mile x 5280	=	Feet
1,000,000 gallons per day	=	694 G.P.M.	Cubic yard x 27	=	Cubic Feet
U.S. gallons x .833	=	British Imperial gallon	Circumference of circe x .3183	=	Diameter of circle
U.S. gallon x 8.336	=	Pounds	Diameter of circe x 3.1416	=	Circumference of circle
Acre foot x 325,850	=	U.S. gallons	Diameter of circle squared x .7854	=	Area of circle
Gallons per day x 1,000,000	=	694 gallons per minute	Radius of circle squared x 3.1416	=	Area of circle
U.S. gallons x 231	=	Cubic inches	Cubic Feet per second x 448.8	=	U.S. gallons per minute
Horsepower (H.P.) x 746	=	Watts	Cubic feet per second	=	Gallons per minute - 449
Horsepower x .746	=	Kilowatts	Velocity in feet per second	=	$\frac{.408 \times \text{U.S. g.p.m.}}{\text{Diam. of pipe squared}}$
					or
					$\frac{144Q \text{ (flow in G.P.M.)}}{A1 \text{ (Pipe ID}^2\text{)}}$

Charts

Resistance and Valve Wire Sizing

Resistance Method

REQUIRED INFORMATION

- Actual one-way length of wire between the controller and the power source or between the controller and valve
- Allowable voltage loss along the wire circuit
- Accumulative current flowing through the wire section being sized in amperes

RESISTANCE IS CALCULATED USING FORMULA:

$$R = \frac{1000 \times AVL}{2L \times I}$$

R = Maximum Allowable Resistance of wire in ohms per 1000 feet

AVL = Allowable voltage loss

L = Wire length (one way)

I = Inrush current

AVL for controller power wire sizing is calculated by subtracting minimum operating voltage required by the controller from minimum available voltage at power source. AVL for valve wire sizing is calculated by subtracting minimum solenoid operating voltage from controller output voltage. This number will vary depending on the manufacturer and in some cases with line pressure.

Valve Wire Sizing Example:

Given: Distance from the controller to the valve is 1800 ft. Controller output is 24V. The valve has a minimum operating voltage of 20V and an inrush current of 370 mA (0.37Amps).

$$R = \frac{1000 \times 4}{2(1800) \times 0.37} \quad R = \frac{4000}{1332} \quad R = 3.00 \text{ ohms/1000 feet}$$

Wire resistance can not exceed 3.00 ohms per 1000 feet. Go to table #1 and select the proper wire size. Since 16 gauge wire has more resistance than 3.00 ohms per 1000 feet, choose 14 gauge wire. Table 2 is a quick reference and is set up to provide maximum wire runs given the information at the bottom of the table.

TABLE 1

Resistance of Copper Wire

WIRE SIZE AWG No.	Resistance at 20° C (68° F) ohms per 1000 Feet
18	6.39
16	4.02
14	2.52
12	1.59
10	1.00
8	0.63
6	0.40
4	0.25

TABLE 2

Valve Wire Sizing (Maximum One-Way Distance in Feet Between Controller and Valve)

GROUND WIRE	CONTROL WIRE						
	18	16	14	12	10	8	6
18	850	1040	1210	1350	1460	1540	1590
16	1040	1340	1650	1920	2150	2330	2440
14	1210	1650	2150	2630	3080	3450	3700
12	1350	1920	2630	3390	4170	4880	5400
10	1460	2150	3080	4170	5400	6670	7690
8	1540	2330	3450	4880	6670	8700	10530
6	1590	2440	3700	5400	7690	10530	13330

Solenoid: 24VAC, Pressure: 150 PSI, Voltage Drop: 4V, Min. Operating Voltage: 20V, Amperage Peak: .37A

FORMULAS

PRECIPITATION RATES	(U.S.)	(METRIC)
Equilateral Triangular Spacing	P.R.= (in/hr) $\frac{(GPM \text{ of } 360) \times 96.25}{(\text{Head Spacing})^2 \times .866}$	P.R.= (mm/hr) $\frac{m3/hr \text{ of } 360 \times 1000}{m2 \times .866}$
Square/Rectangular Spacing	P.R.= (in/hr) $\frac{(GPM \text{ of } 360) \times 96.25}{\text{Head Spacing} \times \text{Row Spacing}}$	P.R.= (mm/hr) $\frac{m3/hr \text{ of } 360 \times 1000}{\text{Head Spacing} \times \text{Row Spacing}}$
Square/Rectangular Spacing for Specific Arc	P.R.= (in/hr) $\frac{3460 \times GPM \text{ (for any arc)}}{\text{Degrees of Arc} \times \text{Head Spacing} \times \text{Row Spacing}}$	P.R.= (mm/hr) $\frac{m3/hr \text{ (for any arc)} \times 1000}{\text{Degrees of Arc} \times \text{Head Spacing} \times \text{Row Spacing}}$
Horsepower	H.P. = $\frac{GPM \times Ft \text{ of Head}}{3,960 \times \text{Pump Efficiency (expressed as a decimal)}}$	
Station Run Time	S.R.T.= (min/wk) $\frac{\text{Total Weekly Req'd (inch/wk)} \times 60 \text{ (min/hr)}}{\text{Precipitation Rate (in/hr)}}$	S.R.T.= (min/wk) $\frac{\text{Total Weekly Req'd (mm/wk)} \times 60 \text{ (min/hr)}}{\text{Precipitation Rate (mm/hr)}}$
Pipe Velocity	V= (ft/sec) $\frac{0.4085 \times \text{Flow (GPM)}}{(\text{Inside Pipe Diameter in Inches})^2}$	V= (m/sec) $\frac{1273.24 \times \text{Flow (l/sec)}}{(\text{Inside Pipe Diameter in Millimeters})^2}$
Scheduling Coefficient	S.C.= $\frac{\text{Average Precipitation Rate (in/hr)}}{\text{Lowest Precipitation Rate (in/hr)}}$	S.C.= $\frac{\text{Average Precipitation Rate (mm/hr)}}{\text{Lowest Precipitation Rate (mm/hr)}}$
Slope	S= $\frac{\text{Rise (Measure of Length)}}{\text{Run (Measure of Length)}}$	

PVC Schedule 40 IPS Plastic Pipe

SIZES: 1/2" – 6" **FLOW:** 1 – 600 GPM **PSI LOSS:** Per 100' of tube (PSI/100 FT) **C = 150 (1120, 1220)**

SIZE	1/2"		3/4"		1"		1 1/4"		1 1/2"		2"		2 1/2"		3"		4"		6"	
OD	0.840		1.050		1.315		1.660		1.900		2.375		2.875		3.500		4.500		6.625	
ID	0.622		0.824		1.049		1.380		1.610		2.067		2.469		3.068		4.026		6.065	
WALL THK.	0.109		0.113		0.133		0.140		0.145		0.154		0.203		0.216		0.237		0.280	
FLOW G. P. M.	Velocity FPS	psi Loss	Velocity FPS	psi Loss	Velocity FPS	psi Loss	Velocity FPS	psi Loss	Velocity FPS	psi Loss	Velocity FPS	psi Loss	Velocity FPS	psi Loss	Velocity FPS	psi Loss	Velocity FPS	psi Loss	Velocity FPS	psi Loss
1	1.05	0.43	0.60	0.11	0.37	0.03	0.21	0.01	0.15	0.00										
2	2.11	1.55	1.20	0.39	0.74	0.12	0.42	0.03	0.31	0.02	0.19	0.00								
3	3.16	3.28	1.80	0.84	1.11	0.26	0.64	0.07	0.47	0.03	0.28	0.01	0.20	0.00						
4	4.22	5.60	2.40	1.42	1.48	0.44	0.85	0.12	0.62	0.05	0.38	0.02	0.26	0.01						
5	5.27	8.46	3.00	2.15	1.85	0.66	1.07	0.18	0.78	0.08	0.47	0.02	0.33	0.01	0.21	0.00				
6	6.33	11.86	3.60	3.02	2.22	0.93	1.28	0.25	0.94	0.12	0.57	0.03	0.40	0.01	0.26	0.01				
7	7.38	15.77	4.20	4.01	2.59	1.24	1.49	0.33	1.10	0.15	0.66	0.05	0.46	0.02	0.30	0.01				
8	8.44	20.20	4.80	5.14	2.96	1.59	1.71	0.42	1.25	0.20	0.76	0.06	0.53	0.02	0.34	0.01				
9	9.49	25.12	5.40	6.39	3.33	1.97	1.92	0.52	1.41	0.25	0.85	0.07	0.60	0.03	0.39	0.01				
10	10.55	30.54	6.00	7.77	3.70	2.40	2.14	0.63	1.57	0.30	0.95	0.09	0.66	0.04	0.43	0.01				
11	11.60	36.43	6.60	9.27	4.07	2.86	2.35	0.75	1.73	0.36	1.05	0.11	0.73	0.04	0.47	0.02				
12	12.65	42.80	7.21	10.89	4.44	3.36	2.57	0.89	1.88	0.42	1.14	0.12	0.80	0.05	0.52	0.02	0.30	0.00		
14	14.76	56.94	8.41	14.48	5.19	4.47	2.99	1.18	2.20	0.56	1.33	0.17	0.93	0.07	0.60	0.02	0.35	0.01		
16	16.87	72.92	9.61	18.55	5.93	5.73	3.42	1.51	2.51	0.71	1.52	0.21	1.07	0.09	0.69	0.03	0.40	0.01		
18	18.98	90.69	10.81	23.07	6.67	7.13	3.85	1.88	2.83	0.89	1.71	0.26	1.20	0.11	0.78	0.04	0.45	0.01		
20	21.09	110.23	12.01	28.04	7.41	8.66	4.28	2.28	3.14	1.08	1.90	0.32	1.33	0.13	0.86	0.05	0.50	0.01		
22			13.21	33.45	8.15	10.33	4.71	2.72	3.46	1.29	2.10	0.38	1.47	0.16	0.95	0.06	0.55	0.01		
24			14.42	39.30	8.89	12.14	5.14	3.20	3.77	1.51	2.29	0.45	1.60	0.19	1.04	0.07	0.60	0.02		
26			15.62	45.58	9.64	14.08	5.57	3.17	4.09	1.75	2.48	0.52	1.74	0.22	1.12	0.08	0.65	0.02		
28			16.82	52.28	10.38	16.15	5.99	4.25	4.40	2.01	2.67	0.60	1.87	0.25	1.21	0.09	0.70	0.02		
30			18.02	59.41	11.12	18.35	6.42	4.83	4.72	2.28	2.86	0.68	2.00	0.29	1.30	0.10	0.75	0.03		
35					12.97	24.42	7.49	6.43	5.50	3.04	3.34	0.90	2.34	0.38	1.51	0.13	0.88	0.04	0.38	0.00
40					14.83	31.27	8.56	8.23	6.29	3.89	3.81	1.15	2.67	0.49	1.73	0.17	1.00	0.04	0.44	0.01
45					16.68	38.89	9.64	10.24	7.08	4.84	4.29	1.43	3.01	0.60	1.95	0.21	1.13	0.06	0.49	0.01
50					18.53	47.27	10.71	12.45	7.87	5.88	4.77	1.74	3.34	0.73	2.16	0.26	1.25	0.07	1.55	0.01
55							11.78	14.85	8.65	7.01	5.25	2.08	3.68	0.88	2.38	0.30	1.38	0.08	0.61	0.01
60							12.85	17.45	9.44	8.24	5.72	2.44	4.01	1.03	2.60	0.36	1.51	0.10	0.66	0.01
65							13.92	20.23	10.23	9.56	6.20	2.83	4.35	1.19	2.81	0.41	1.63	0.11	0.72	0.02
70							14.99	23.21	11.01	10.96	6.68	3.25	4.68	1.37	3.03	0.48	1.76	0.13	0.77	0.02
75							16.06	26.37	11.80	12.46	7.16	3.69	5.01	1.56	3.25	0.54	1.88	0.14	0.83	0.02
80							17.13	29.72	12.59	14.04	7.63	4.16	5.35	1.75	3.46	0.61	2.01	0.16	0.88	0.02
85							18.21	33.26	13.37	15.71	8.11	4.66	5.68	1.96	3.68	0.68	2.13	0.18	0.94	0.02
90							19.28	36.97	14.16	17.46	8.59	5.18	6.02	2.18	3.90	0.76	2.26	0.20	0.99	0.03
95									14.95	19.30	9.07	5.72	6.35	2.41	4.11	0.84	2.39	0.22	1.05	0.03
100									15.74	21.22	9.54	6.29	6.69	2.65	4.33	0.92	2.51	0.25	1.10	0.03
110									17.31	25.32	10.50	7.51	7.36	3.16	4.76	1.10	2.76	0.29	1.22	0.04
120									18.88	29.75	11.45	8.82	8.03	3.72	5.20	1.29	3.02	0.34	1.33	0.05
130											12.41	10.23	8.70	4.31	5.63	1.50	3.27	0.40	1.44	0.05
140											13.36	11.74	9.37	4.94	6.06	1.72	3.52	0.46	1.55	0.06
150											14.32	13.33	10.03	5.62	6.50	1.95	3.77	0.52	1.66	0.07
160											15.27	15.03	10.70	6.33	6.93	2.20	4.02	0.59	1.77	0.08
170											16.23	16.81	11.37	7.08	7.36	2.46	4.27	0.66	1.88	0.09
180											17.18	18.69	12.04	7.87	7.80	2.74	4.53	0.73	1.99	0.10
190											18.14	20.66	12.71	8.70	8.23	3.02	4.78	0.81	2.10	0.11
200											19.09	22.72	13.38	9.57	8.66	3.33	5.03	0.89	2.21	0.12
225													15.05	11.90	9.75	4.14	5.66	1.10	2.49	0.15
250													16.73	14.47	10.83	5.03	6.29	1.34	2.77	0.18
275													18.40	17.26	11.92	6.00	6.92	1.60	3.05	0.22
300															13.00	7.05	7.55	1.88	3.32	0.26
325															14.08	8.17	8.18	2.18	3.60	0.30
350															15.17	9.38	8.81	2.50	3.88	0.34
375															16.25	10.65	9.43	2.84	4.15	0.39
400															17.33	12.01	10.06	3.20	4.43	0.44
425															18.42	13.43	10.69	3.58	4.71	0.49
450															19.50	14.93	11.32	3.98	4.99	0.54
475																	11.95	4.40	5.26	0.60
500																	12.58	4.84	5.54	0.66
550																	13.84	5.77	6.10	0.79
600																	15.10	6.78	6.65	0.92

Note: Shaded areas of the chart indicate velocities over 5 feet per second (FPS). Use with caution.

Charts

PVC Schedule 80 IPS Plastic Pipe

SIZES: 1/2" – 6" **FLOW:** 1 – 600 GPM **PSI LOSS:** Per 100' of tube (PSI/100 FT) **C = 150 (1120, 1220)**

SIZE	1/2"		3/4"		1"		1 1/4"		1 1/2"		2"		2 1/2"		3"		4"		6"	
OD	0.840		1.050		1.315		1.660		1.900		2.375		2.875		3.500		4.500		6.625	
ID	0.546		0.742		0.957		1.278		1.500		1.939		2.323		2.900		3.826		5.761	
WALL THK.	0.147		0.154		0.179		0.191		0.200		0.218		0.276		0.300		0.337		0.432	
FLOW G. P. M.	Velocity FPS	psi Loss	Velocity FPS	psi Loss	Velocity FPS	psi Loss	Velocity FPS	psi Loss	Velocity FPS	psi Loss	Velocity FPS	psi Loss	Velocity FPS	psi Loss	Velocity FPS	psi Loss	Velocity FPS	psi Loss	Velocity FPS	psi Loss
1	1.36	0.81	0.74	0.18	0.44	0.05	0.24	0.01	0.18	0.01	0.10	0.00								
2	2.73	2.92	1.48	0.66	0.89	0.19	0.49	0.05	0.36	0.02	0.21	0.01	0.15	0.00						
3	4.10	6.19	2.22	1.39	1.33	0.40	0.74	0.10	0.54	0.05	0.32	0.01	0.22	0.01						
4	5.47	10.54	2.96	2.37	1.78	0.69	0.99	0.17	0.72	0.08	0.43	0.02	0.30	0.01						
5	6.84	15.93	3.70	3.58	2.22	1.04	1.24	0.25	0.90	0.12	0.54	0.03	0.37	0.01	0.24	0.00				
6	8.21	22.33	4.44	5.02	2.67	1.46	1.49	0.36	1.08	0.16	0.65	0.05	0.45	0.02	0.29	0.01				
7	9.58	29.71	5.18	6.68	3.11	1.94	1.74	0.47	1.26	0.22	0.75	0.06	0.52	0.03	0.33	0.01				
8	10.94	38.05	5.92	8.56	3.56	2.48	1.99	0.61	1.45	0.28	0.86	0.08	0.60	0.03	0.38	0.01				
9	12.31	47.33	6.66	10.64	4.00	3.09	2.24	0.76	1.63	0.35	0.97	0.10	0.68	0.04	0.43	0.01				
10	13.68	57.52	7.41	12.93	4.45	3.75	2.49	0.92	1.81	0.42	1.08	0.12	0.75	0.05	0.48	0.02	0.27	0.00		
11	15.05	68.63	8.15	15.43	4.90	4.47	2.74	1.10	1.99	0.50	1.19	0.14	0.83	0.06	0.53	0.02	0.30	0.01		
12	16.42	80.63	8.89	18.13	5.34	5.26	2.99	1.29	2.17	0.59	1.30	0.17	0.90	0.07	0.58	0.02	0.33	0.01		
14			10.37	24.12	6.23	6.99	3.49	1.71	2.53	0.79	1.51	0.23	1.05	0.09	0.67	0.03	0.39	0.01		
16			11.85	30.88	7.12	8.95	3.99	2.19	2.90	1.01	1.73	0.29	1.20	0.12	0.77	0.04	0.44	0.01		
18			13.33	38.41	8.01	11.14	4.49	2.73	3.26	1.26	1.95	0.36	1.36	0.15	0.87	0.05	0.50	0.01		
20			14.82	46.69	8.90	13.54	4.99	3.31	3.62	1.52	2.17	0.44	1.51	0.18	0.97	0.06	0.55	0.02		
22			16.30	55.70	9.80	16.15	5.49	3.95	3.98	1.81	2.38	0.52	1.66	0.22	1.06	0.07	0.61	0.02		
24			17.78	65.44	10.69	18.97	5.99	4.64	4.35	2.13	2.60	0.61	1.81	0.25	1.16	0.09	0.66	0.02		
26			19.26	75.90	11.58	22.01	6.49	5.39	4.71	2.47	2.82	0.71	1.96	0.29	1.26	0.10	0.72	0.03		
28					12.47	25.24	6.99	6.18	5.07	2.83	3.03	0.81	2.11	0.34	1.35	0.11	0.78	0.03		
30					13.36	28.69	7.49	7.02	5.43	3.22	3.25	0.92	2.26	0.38	1.45	0.13	0.83	0.03	0.36	0.00
35					15.59	38.16	8.74	9.34	6.34	4.29	3.79	1.23	2.64	0.51	1.69	0.17	0.97	0.05	0.43	0.01
40					17.81	48.87	9.99	11.96	7.25	5.49	4.34	1.57	3.02	0.65	1.94	0.22	1.11	0.06	0.49	0.01
45					11.24	14.88	8.16	6.83	4.88	1.96	3.40	0.81	2.18	0.28	1.25	0.07	0.55	0.01		
50					12.49	18.09	9.06	8.30	5.42	2.38	3.78	0.99	2.42	0.34	1.39	0.09	0.61	0.01		
55					13.73	21.58	9.97	9.90	5.96	2.84	4.15	1.18	2.66	0.40	1.53	0.10	0.67	0.01		
60					14.98	25.35	10.87	11.63	6.51	3.33	4.53	1.38	2.91	0.47	1.67	0.12	0.73	0.02		
65					16.23	29.40	11.78	13.49	7.05	3.87	4.91	1.61	3.15	0.55	1.81	0.14	0.79	0.02		
70					17.48	33.72	12.69	15.47	7.59	4.44	5.29	1.84	3.39	0.63	1.95	0.16	0.86	0.02		
75					18.73	38.32	13.59	17.58	8.13	5.04	5.67	2.09	3.63	0.71	2.09	0.18	0.92	0.03		
80					19.98	43.19	14.50	19.81	8.68	5.68	6.04	2.36	3.88	0.80	2.22	0.21	0.98	0.03		
85							15.41	22.16	9.22	6.36	6.42	2.63	4.12	0.90	2.36	0.23	1.04	0.03		
90							16.32	24.64	9.76	7.07	6.80	2.93	4.36	1.00	2.50	0.26	1.10	0.04		
95							17.22	27.23	10.30	7.81	7.18	3.24	4.60	1.10	2.64	0.29	1.16	0.04		
100							18.13	29.95	10.85	8.59	7.56	3.57	4.85	1.21	2.78	0.31	1.22	0.04		
110							19.94	35.73	11.93	10.25	8.31	4.25	5.33	1.45	3.06	0.38	1.35	0.05		
120									13.02	12.04	9.07	5.00	5.82	1.70	3.34	0.44	1.47	0.06		
130									14.10	13.96	9.82	5.60	6.30	1.97	3.62	0.51	1.59	0.07		
140									15.19	16.02	10.58	6.65	6.79	2.27	3.90	0.59	1.72	0.08		
150									16.27	18.20	11.34	7.56	7.27	2.57	4.18	0.67	1.84	0.09		
160									17.36	20.51	12.09	8.51	7.76	2.89	4.45	0.75	1.96	0.10		
170									18.44	22.95	12.85	9.53	8.24	3.24	4.73	0.84	2.08	0.11		
180									19.53	25.51	13.60	10.59	8.73	3.60	5.01	0.93	2.21	0.13		
190											14.36	11.71	9.21	3.98	5.29	1.03	2.33	0.14		
200											15.12	12.87	9.70	4.37	5.57	1.14	2.45	0.16		
225											17.01	16.01	10.91	5.44	6.27	1.41	2.76	0.19		
250											18.90	19.46			12.12	6.61	6.96	1.72	3.07	0.23
275															13.34	7.89	7.66	2.05	3.38	0.28
300															14.55	9.27	8.36	2.41	3.68	0.33
325															15.76	10.75	9.05	2.79	3.99	0.38
350															16.97	12.33	9.75	3.20	4.30	0.44
375															18.19	14.01	10.45	3.64	4.60	0.50
400															19.40	15.79	11.14	4.10	4.91	0.56
425																	11.84	4.59	5.22	0.63
450																	12.54	5.10	5.53	0.70
475																	13.23	5.64	5.83	0.77
500																	13.93	6.20	6.14	0.85
550																	15.32	7.40	6.76	1.01
600																	16.72	8.69	7.37	1.19

Note: Shaded areas of the chart indicate velocities over 5 feet per second (FPS). Use with caution.

Velocity of flow rate values are computed from the general equation $V = .408 Q/d^2$

Friction pressure loss values are computed from the equation $[hf = 0.2083 (100/C) 1.852 Q^{1.852}/d^{4.868}] \times .433$ for psi loss per 100' of pipe.

PVC Class 125 IPS Plastic Pipe

SIZES: 1" – 6" **FLOW:** 1 – 600 GPM **PSI LOSS:** Per 100' of tube (PSI/100 FT) **C = 150** (1120, 1220) SDR 32.5

SIZE	1"		1 1/4"		1 1/2"		2"		2 1/2"		3"		4"		6"	
OD	1.315	1.660	1.900	2.375	2.875	3.500	4.500	6.625								
ID	1.211	1.548	1.784	2.229	2.699	3.284	4.224	6.217								
WALL THK.	0.052	0.056	0.058	0.073	0.088	0.108	0.138	0.204								
FLOW G. P. M.	Velocity FPS	psi Loss	Velocity FPS	psi Loss	Velocity FPS	psi Loss	Velocity FPS	psi Loss	Velocity FPS	psi Loss	Velocity FPS	psi Loss	Velocity FPS	psi Loss	Velocity FPS	psi Loss
1	0.27	0.02	0.17	0.01	0.12	0.00										
2	0.55	0.06	0.34	0.02	0.25	0.01	0.16	0.00								
3	0.83	0.13	0.51	0.04	0.38	0.02	0.24	0.01								
4	1.11	0.22	0.68	0.07	0.51	0.03	0.32	0.01	0.22	0.00						
5	1.39	0.33	0.85	0.10	0.64	0.05	0.41	0.02	0.28	0.01						
6	1.66	0.46	1.02	0.14	0.76	0.07	0.49	0.02	0.33	0.01						
7	1.94	0.62	1.19	0.19	0.89	0.09	0.57	0.03	0.39	0.01	0.26	0.00				
8	2.22	0.79	1.36	0.24	1.02	0.12	0.65	0.04	0.44	0.02	0.30	0.01				
9	2.50	0.98	1.53	0.30	1.15	0.15	0.73	0.05	0.50	0.02	0.34	0.01				
10	2.78	1.19	1.70	0.36	1.28	0.18	0.82	0.06	0.56	0.02	0.37	0.01				
11	3.06	1.42	1.87	0.43	1.41	0.22	0.90	0.07	0.61	0.03	0.41	0.01				
12	3.33	1.67	2.04	0.51	1.53	0.25	0.98	0.09	0.67	0.03	0.45	0.01	0.27	0.00		
14	3.89	2.22	2.38	0.67	1.79	0.34	1.14	0.11	0.78	0.05	0.52	0.02	0.32	0.01		
16	4.45	2.85	2.72	0.86	2.05	0.43	1.31	0.15	0.89	0.06	0.60	0.02	0.36	0.01		
18	5.00	3.54	3.06	1.07	2.30	0.54	1.47	0.18	1.00	0.07	0.68	0.03	0.41	0.01		
20	5.56	4.31	3.40	1.30	2.56	0.65	1.64	0.22	1.12	0.09	0.75	0.03	0.45	0.01		
22	6.12	5.14	3.74	1.56	2.82	0.78	1.80	0.26	1.23	0.10	0.83	0.04	0.50	0.01		
24	6.67	6.04	4.08	1.83	3.07	0.92	1.97	0.31	1.34	0.12	0.90	0.05	0.54	0.01		
26	7.23	7.00	4.42	2.12	3.33	1.06	2.13	0.36	1.45	0.14	0.98	0.05	0.59	0.02		
28	7.78	8.03	4.76	2.43	3.58	1.22	2.29	0.41	1.56	0.16	1.05	0.06	0.644	0.02		
30	8.34	9.13	5.10	2.76	3.84	1.39	2.46	0.47	1.68	0.18	1.13	0.07	0.68	0.02		
35	9.73	12.14	5.95	3.68	4.48	1.84	2.87	0.62	1.96	0.25	1.32	0.09	0.80	0.03	0.36	0.00
40	11.12	15.55	6.81	4.71	5.12	2.36	3.28	0.80	2.24	0.31	1.51	0.12	0.91	0.04	0.42	0.01
45	12.51	19.34	7.66	5.86	5.76	2.94	3.69	0.99	2.52	0.39	1.70	0.15	1.02	0.04	0.47	0.01
50	13.91	23.50	8.51	7.12	6.40	3.57	4.10	1.21	2.80	0.48	1.89	0.18	1.14	0.05	0.52	0.01
55	15.30	28.04	9.36	8.49	7.05	4.26	4.51	1.44	3.08	0.57	2.08	0.22	1.25	0.06	0.58	0.01
60	16.69	32.94	10.21	9.98	7.69	5.00	4.92	1.69	3.36	0.67	2.26	0.26	1.37	0.085	0.63	0.01
65	18.08	38.21	11.06	11.57	8.33	5.80	5.33	1.96	3.64	0.77	2.45	0.30	1.48	0.09	0.68	0.01
70	19.47	43.83	11.91	13.27	8.97	6.65	5.74	2.25	3.92	0.89	2.64	0.34	1.60	0.10	0.73	0.02
75			12.76	15.08	9.61	7.56	6.15	2.56	4.20	1.01	2.83	0.39	1.71	0.11	0.79	0.02
80			13.62	17.00	10.25	8.52	6.56	2.88	4.48	1.14	3.02	0.44	1.82	0.13	0.84	0.02
85			14.47	19.02	10.89	9.53	6.98	3.23	4.76	1.27	3.21	0.49	1.94	0.14	0.89	0.02
90			15.32	21.14	11.53	10.60	7.39	3.59	5.04	1.41	3.40	0.54	2.05	0.16	0.95	0.02
95			16.17	23.37	12.17	11.71	7.80	3.96	5.32	1.56	3.59	0.60	2.17	0.18	1.00	0.03
100			17.02	25.69	12.81	12.88	8.21	4.36	5.60	1.72	3.78	0.66	2.28	0.19	1.05	0.03
110			18.72	3.65	14.10	15.37	9.03	5.20	6.16	2.05	4.16	0.79	2.51	0.23	1.16	0.04
120					15.38	18.06	9.85	6.11	6.72	2.41	4.53	0.93	2.74	0.27	1.26	0.04
130					16.66	20.94	10.67	7.09	7.28	2.79	4.91	1.08	2.97	0.32	1.37	0.05
140					17.94	24.02	11.49	8.13	7.84	3.20	5.29	1.23	3.20	0.36	1.47	0.06
150					19.22	27.30	12.31	9.24	8.40	3.64	5.67	1.40	3.43	0.41	1.58	0.06
160							13.13	10.41	8.96	4.10	6.05	1.58	3.65	0.46	1.68	0.07
170							13.96	11.65	9.52	4.59	6.43	1.77	3.88	0.52	1.79	0.08
180							14.78	12.95	10.08	5.10	6.80	1.96	4.11	0.58	1.90	0.09
190							15.60	14.31	10.64	5.64	7.18	2.17	4.34	0.64	2.00	0.10
200							16.42	15.74	11.20	6.20	7.56	2.39	4.57	0.70	2.11	0.11
225							18.47	19.57	12.60	7.72	8.51	2.97	5.14	0.87	2.37	0.13
250									14.00	9.38	9.45	3.61	5.71	1.06	2.63	0.16
275									15.40	11.19	10.40	4.31	6.28	1.27	2.90	0.19
300									16.80	13.15	11.34	5.06	6.86	1.49	3.16	0.23
325									18.20	15.25	12.29	5.87	7.43	1.72	3.43	0.26
350									19.60	17.49	13.24	6.73	8.00	1.98	3.69	0.30
375											14.18	7.65	8.57	2.25	3.95	0.34
400											15.13	8.62	9.14	2.53	4.22	0.39
425											16.07	9.65	9.71	2.83	4.48	0.43
450											17.02	10.72	10.29	3.15	4.75	0.48
475											17.96	11.85	10.86	3.48	5.01	0.53
500											18.91	13.03	11.43	3.83	5.27	0.58
550													12.57	4.57	5.80	0.70
600													13.72	5.37	6.33	0.82

Note: Shaded areas of the chart indicate velocities over 5 feet per second (FPS). Use with caution.

Charts

PVC Class 160 IPS Plastic Pipe

SIZES: 1" – 6" **FLOW:** 1 – 600 GPM **PSI LOSS:** Per 100' of tube (PSI/100 FT) **C = 150** (1120, 1220) SDR 26

SIZE	1"		1 1/4"		1 1/2"		2"		2 1/2"		3"		4"		6"	
OD	1.315	1.660	1.900	2.375	2.875	3.500	4.500	6.625								
ID	1.195	1.532	1.754	2.193	2.655	3.230	4.154	6.115								
WALL THK.	0.060	0.064	0.073	0.091	0.110	0.135	0.173	0.225								
FLOW G. P. M.	Velocity FPS	psi Loss	Velocity FPS	psi Loss	Velocity FPS	psi Loss	Velocity FPS	psi Loss	Velocity FPS	psi Loss	Velocity FPS	psi Loss	Velocity FPS	psi Loss	Velocity FPS	psi Loss
1	0.28	0.02	0.17	0.01	0.13	0.00										
2	0.57	0.06	0.34	0.02	0.26	0.01	0.16	0.00								
3	0.85	0.14	0.52	0.04	0.39	0.02	0.25	0.01								
4	1.14	0.23	0.69	0.07	0.53	0.04	0.33	0.01	0.23	0.00						
5	1.42	0.35	0.86	0.11	0.66	0.05	0.42	0.02	0.28	0.01						
6	1.71	0.49	1.04	0.15	0.79	0.08	0.50	0.03	0.34	0.01	0.20	0.00				
7	1.99	0.66	1.21	0.20	0.92	0.10	0.59	0.03	0.40	0.01	0.27	0.01				
8	2.28	0.84	1.39	0.25	1.06	0.13	0.67	0.04	0.46	0.02	0.31	0.01				
9	2.57	1.05	1.56	0.31	1.19	0.16	0.76	0.05	0.52	0.02	0.35	0.01				
10	2.85	1.27	1.73	0.38	1.32	0.20	0.84	0.07	0.57	0.03	0.39	0.01				
11	3.14	1.52	1.91	0.45	1.45	0.23	0.93	0.08	0.63	0.03	0.43	0.01				
12	3.42	1.78	2.085	0.53	1.59	0.28	1.01	0.09	0.69	0.04	0.46	0.01	0.28	0.00		
14	3.99	2.37	2.43	0.71	1.85	0.37	1.18	0.12	0.81	0.05	0.54	0.02	0.33	0.01		
16	4.57	3.04	2.78	0.91	2.12	0.47	1.35	0.16	0.92	0.06	0.62	0.02	0.37	0.01		
18	5.14	3.78	3.12	1.13	2.38	0.58	1.52	0.20	1.04	0.08	0.70	0.03	0.42	0.01		
20	5.71	4.59	3.47	1.37	2.65	0.71	1.69	0.24	1.15	0.09	0.78	0.04	0.47	0.01		
22	6.28	5.48	3.82	1.64	2.91	0.85	1.86	0.29	1.27	0.11	0.86	0.04	0.52	0.01		
24	6.85	6.44	4.17	1.92	3.18	1.00	2.03	0.34	1.38	0.13	0.93	0.05	0.56	0.02		
26	7.42	7.47	4.51	2.23	3.44	1.15	2.20	0.39	1.50	0.15	1.01	0.06	0.61	0.02		
28	7.99	8.57	4.86	2.56	3.71	1.32	2.37	0.45	1.62	0.18	1.09	0.07	0.66	0.02		
30	8.57	9.74	5.21	2.91	3.97	1.50	2.54	0.51	1.73	0.20	1.17	0.08	0.70	0.02		
35	9.99	12.95	6.08	3.87	4.64	2.00	2.96	0.68	2.02	0.27	1.36	0.10	0.82	0.03	0.38	0.00
40	11.42	16.59	6.95	4.95	5.30	2.56	3.39	0.86	2.31	0.34	1.56	0.13	0.94	0.04	0.43	0.01
45	12.85	20.63	7.82	6.16	5.96	3.19	3.81	1.08	2.60	0.42	1.75	0.16	1.06	0.05	0.49	0.01
50	14.28	25.07	8.69	7.49	6.63	3.88	4.24	1.31	2.89	0.52	1.95	0.20	1.18	0.06	0.54	0.01
55	15.71	29.91	9.56	8.93	7.29	4.62	4.66	1.56	3.18	0.62	2.15	0.24	1.30	0.07	0.60	0.01
60	17.14	35.14	10.43	10.49	7.95	5.43	5.09	1.83	3.47	0.72	2.34	0.28	1.41	0.08	0.65	0.01
65	18.57	40.67	11.29	12.17	8.62	6.30	5.51	2.12	3.76	0.84	2.54	0.32	1.53	0.09	0.70	0.01
70	19.99	46.76	12.16	13.96	9.28	7.23	5.93	2.44	4.05	0.96	2.73	0.37	1.65	0.11	0.76	0.02
75			13.03	15.86	9.94	8.21	6.36	2.77	4.34	1.09	2.93	0.42	1.77	0.12	0.81	0.02
80			13.90	17.88	10.60	9.25	6.78	3.12	4.63	1.23	3.12	0.47	1.89	0.14	0.87	0.02
85			14.77	20.00	11.27	10.35	7.21	3.49	4.91	1.38	3.32	0.53	2.00	0.16	0.92	0.02
90			15.64	22.23	11.93	11.51	7.63	3.88	5.20	1.53	3.51	0.59	2.12	0.17	0.98	0.03
95			16.51	24.58	12.59	12.72	8.05	4.29	5.49	1.69	3.71	0.65	2.24	0.19	1.03	0.03
100			17.38	27.03	13.26	13.99	8.48	4.72	5.78	1.86	3.91	0.72	2.36	0.21	1.09	0.03
110			19.12	32.24	14.58	16.69	9.33	5.63	6.36	2.22	4.30	0.86	2.60	0.25	1.20	0.04
120					15.91	19.61	10.18	6.61	6.94	2.61	4.69	1.01	2.83	0.30	1.30	0.05
130					17.24	22.74	11.02	7.67	7.52	3.03	5.08	1.17	3.07	0.34	1.41	0.05
140					18.56	26.09	11.87	8.80	8.10	3.47	5.47	1.34	3.31	0.39	1.52	0.06
150					19.89	29.64	12.72	10.00	8.68	3.94	5.86	1.52	3.54	0.45	1.63	0.07
160							13.57	11.27	9.26	4.45	6.25	1.71	3.78	0.50	1.74	0.08
170							14.42	12.61	9.83	4.97	6.64	1.92	4.01	0.56	1.85	0.09
180							15.27	14.02	10.41	5.53	7.03	2.13	4.25	0.63	1.96	0.10
190							16.11	15.49	10.99	6.11	7.43	2.35	4.49	0.69	2.07	0.11
200							16.96	17.03	11.57	6.72	7.82	2.59	4.72	0.76	2.18	0.12
225							19.08	21.19	13.02	8.36	8.79	3.22	5.31	0.95	2.45	0.14
250									14.47	10.16	9.77	3.91	5.91	1.15	2.72	0.18
275									15.91	12.12	10.75	4.67	6.50	1.37	3.00	0.21
300									17.36	14.24	11.73	5.49	7.09	1.61	3.27	0.25
325									18.81	16.51	12.70	6.36	7.68	1.87	3.54	0.29
350											13.68	7.30	8.27	2.15	3.81	0.33
375											14.66	8.29	8.86	2.44	4.09	0.37
400											15.64	9.35	9.45	2.75	4.36	0.42
425											16.62	10.46	10.04	3.07	4.63	0.47
450											17.59	11.62	10.63	3.42	4.90	0.52
475											18.57	12.85	11.23	3.78	5.18	0.58
500											19.55	14.13	11.82	4.15	5.45	0.63
550													13.00	4.96	6.00	0.76
600													14.18	5.82	6.54	0.89

Note: Shaded areas of the chart indicate velocities over 5 feet per second (FPS). Use with caution.

PVC Class 200 IPS Plastic Pipe

SIZES: 3/4" – 6" **FLOW:** 1 – 600 GPM **PSI LOSS:** Per 100' of pipe (PSI/100 FT) **C = 150** (1120, 1220) SDR 21

SIZE	3/4"		1"		1 1/4"		1 1/2"		2"		2 1/2"		3"		4"		6"	
OD	1.050		1.315		1.660		1.900		2.375		2.875		3.500		4.500		6.625	
ID	0.930		1.189		1.502		1.720		2.149		2.601		3.166		4.072		5.993	
WALL THK.	0.060		0.063		0.079		0.090		0.113		0.137		0.167		0.214		0.316	
FLOW G. P. M.	Velocity FPS	psi Loss	Velocity FPS	psi Loss	Velocity FPS	psi Loss	Velocity FPS	psi Loss	Velocity FPS	psi Loss	Velocity FPS	psi Loss	Velocity FPS	psi Loss	Velocity FPS	psi Loss	Velocity FPS	psi Loss
1	0.47	0.06	0.28	0.02	0.18	0.01	0.13	0.00										
2	0.94	0.22	0.57	0.07	0.36	0.02	0.27	0.01	0.17	0.00								
3	1.42	0.46	0.86	0.14	0.54	0.04	0.41	0.02	0.26	0.01	0.18	0.00						
4	1.89	0.79	1.15	0.24	0.72	0.08	0.55	0.04	0.35	0.01	0.24	0.01						
5	2.36	1.20	1.44	0.36	0.90	0.12	0.68	0.06	0.44	0.02	0.30	0.01						
6	2.83	1.68	1.73	0.51	1.08	0.16	0.82	0.08	0.53	0.03	0.36	0.01	0.24	0.00				
7	3.30	2.23	2.02	0.67	1.26	0.22	0.96	0.11	0.61	0.04	0.42	0.01	0.28	0.01				
8	3.77	2.85	2.30	0.86	1.44	0.28	1.10	0.14	0.70	0.05	0.48	0.02	0.32	0.01				
9	4.25	3.55	2.59	1.07	1.62	0.34	1.24	0.18	0.79	0.06	0.54	0.02	0.36	0.01				
10	4.72	4.31	2.88	1.30	1.80	0.42	1.37	0.22	0.88	0.07	0.60	0.03	0.40	0.01				
11	5.19	5.15	3.17	1.56	1.98	0.50	1.51	0.26	0.97	0.09	0.66	0.03	0.44	0.01				
12	5.66	6.05	3.46	1.83	2.17	0.59	1.65	0.30	1.06	0.10	0.72	0.04	0.48	0.02	0.29	0.00		
14	6.60	8.05	4.04	2.43	2.53	0.78	1.93	0.40	1.23	0.14	0.84	0.05	0.56	0.02	0.34	0.01		
16	7.55	10.30	4.61	3.11	2.89	1.00	2.20	0.52	1.41	0.17	0.96	0.07	0.65	0.03	0.39	0.01		
18	8.49	12.81	5.19	3.87	3.25	1.24	2.48	0.64	1.59	0.22	1.08	0.09	0.73	0.03	0.44	0.01		
20	9.43	15.58	5.77	4.71	3.61	1.51	2.75	0.78	1.76	0.26	1.20	0.10	0.81	0.04	0.49	0.01		
22	10.38	18.58	6.34	5.62	3.97	1.80	3.03	0.93	1.94	0.32	1.32	0.12	0.89	0.05	0.54	0.01		
24	11.32	21.83	6.92	6.60	4.34	2.12	3.30	1.09	2.12	0.37	1.44	0.15	0.97	0.06	0.59	0.02		
26	12.27	25.32	7.50	7.65	4.70	2.46	3.58	1.27	2.29	0.43	1.56	0.17	1.05	0.07	0.63	0.02		
28	13.21	29.04	8.08	8.78	5.06	2.82	3.86	1.46	2.47	0.49	1.68	0.19	1.13	0.07	0.68	0.02		
30	14.15	33.00	8.65	9.98	5.42	3.20	4.13	1.66	2.65	0.56	1.80	0.22	1.22	0.09	0.73	0.02	0.34	0.00
35	16.51	43.91	10.10	13.27	6.32	4.26	4.82	2.20	3.09	0.75	2.11	0.29	1.42	0.11	0.86	0.03	0.39	0.01
40	18.87	56.23	11.54	17.00	7.23	5.45	5.51	2.82	3.53	0.95	2.41	0.38	1.62	0.14	0.98	0.04	0.45	0.01
45			12.98	21.14	8.13	6.78	6.20	3.51	3.97	1.19	2.71	0.47	1.83	0.18	1.10	0.05	0.51	0.01
50			14.42	25.70	9.04	8.24	6.89	4.26	4.41	1.44	3.01	0.57	2.03	0.22	1.23	0.06	0.56	0.01
55			15.87	30.66	9.94	9.83	7.58	5.09	4.85	1.72	3.31	0.68	2.23	0.26	1.35	0.08	0.62	0.01
60			17.31	36.02	10.85	11.55	8.27	5.97	5.30	2.02	3.61	0.80	2.44	0.31	1.47	0.09	0.68	0.01
65			18.75	41.77	11.75	13.40	8.96	6.93	5.74	2.35	3.92	0.93	2.64	0.36	1.59	0.10	0.73	0.02
70					12.65	15.37	9.65	7.95	6.18	2.69	4.22	1.06	2.84	0.41	1.72	0.12	0.79	0.02
75					13.56	17.47	10.34	9.03	6.62	3.06	4.52	1.21	3.05	0.46	1.84	0.14	0.85	0.02
80					14.46	19.68	11.03	10.18	7.06	3.44	4.82	1.36	3.25	0.52	1.96	0.15	0.90	0.02
85					15.37	22.02	11.72	11.39	7.50	3.85	5.12	1.52	3.45	0.59	2.09	0.17	0.96	0.03
90					16.27	24.48	12.41	12.66	7.95	4.28	5.42	1.69	3.66	0.65	2.21	0.19	1.02	0.03
95					17.18	27.06	13.10	13.99	8.39	4.74	5.72	1.87	3.86	0.72	2.33	0.21	1.07	0.03
100					18.08	29.76	13.79	15.39	8.83	5.21	6.03	2.06	4.07	0.79	2.46	0.23	1.13	0.04
110					19.89	35.50	15.17	18.36	9.71	6.21	6.63	2.45	4.47	0.94	2.70	0.28	1.24	0.04
120							16.54	21.57	10.60	7.30	7.23	2.88	4.88	1.11	2.95	0.33	1.36	0.05
130							17.92	25.02	11.48	8.47	7.84	3.34	5.29	1.29	3.19	0.38	1.47	0.06
140							19.30	28.70	12.36	9.71	8.44	3.84	5.69	1.47	3.44	0.43	1.59	0.07
150									13.25	11.04	9.04	4.36	6.10	1.68	3.69	0.49	1.70	0.08
160									14.13	12.44	9.64	4.91	6.51	1.89	3.93	0.55	1.81	0.08
170									15.01	13.91	10.25	5.50	6.91	2.11	4.18	0.62	1.93	0.09
180									15.90	15.47	10.85	6.11	7.32	2.35	4.42	0.69	2.04	0.11
190									16.78	17.10	11.45	6.75	7.73	2.60	4.67	0.76	2.15	0.12
200									17.66	18.80	12.06	7.43	8.14	2.85	4.92	0.84	2.27	0.13
225									19.87	23.38	13.56	9.24	9.15	3.55	5.53	1.04	2.55	0.16
250											15.07	11.23	10.17	4.31	6.15	1.27	2.83	0.19
275											16.58	13.39	11.19	5.15	6.76	1.51	3.12	0.23
300											18.09	15.74	12.21	6.05	7.38	1.78	3.40	0.27
325											19.60	18.25	13.22	7.01	7.99	2.06	3.69	0.31
350													14.24	8.05	8.61	2.36	3.97	0.36
375													15.26	9.14	9.22	2.69	4.25	0.41
400													16.28	10.30	9.84	3.03	4.54	0.46
425													17.29	11.53	10.45	3.396	4.82	0.52
450													18.31	12.81	11.07	3.77	5.11	0.57
475													19.33	14.16	11.68	4.16	5.39	0.63
500															12.30	4.58	5.67	0.70
550															13.53	5.46	6.24	0.83
600															14.76	6.42	6.81	0.98

Note: Shaded areas of the chart indicate velocities over 5 feet per second (FPS). Use with caution.

Charts

PVC Class 315 IPS Plastic Pipe

SIZES: 1/2" – 6" **FLOW:** 1 – 600 GPM **PSI LOSS:** Per 100' of pipe (PSI/100 FT) **C = 150** (1120, 1220) SDR 13.5

SIZE	1/2"		3/4"		1"		1 1/4"		1 1/2"		2"		2 1/2"		3"		4"		6"	
OD	0.840		1.050		1.315		1.660		1.900		2.375		2.875		3.500		4.500		6.625	
ID	0.716		0.894		1.121		1.414		1.618		2.023		2.449		2.982		3.834		5.643	
WALL THK.	0.062		0.078		0.097		0.123		0.141		0.176		0.213		0.259		0.333		0.491	
FLOW G. P. M.	Velocity FPS	psi Loss	Velocity FPS	psi Loss	Velocity FPS	psi Loss	Velocity FPS	psi Loss	Velocity FPS	psi Loss	Velocity FPS	psi Loss	Velocity FPS	psi Loss	Velocity FPS	psi Loss	Velocity FPS	psi Loss	Velocity FPS	psi Loss
1	0.79	0.22	0.51	0.07	0.32	0.02	0.20	0.01	0.15	0.00										
2	1.59	0.78	1.02	0.27	0.64	0.09	0.40	0.03	0.31	0.01	0.19	0.00								
3	2.38	1.65	1.53	0.56	0.97	0.19	0.61	0.06	0.46	0.03	0.29	0.01	0.20	0.00						
4	3.18	2.82	2.04	0.96	1.29	0.32	0.81	0.10	0.62	0.05	0.39	0.02	0.27	0.01						
5	3.97	4.26	2.55	1.45	1.62	0.48	1.02	0.16	0.77	0.08	0.49	0.03	0.34	0.01	0.22	0.00				
6	4.77	5.97	3.06	2.03	1.94	0.67	1.22	0.22	0.93	0.11	0.59	0.04	0.40	0.02	0.27	0.01				
7	5.57	7.95	3.57	2.70	2.27	0.90	1.42	0.29	1.09	0.15	0.69	0.05	0.47	0.02	0.32	0.01				
8	6.36	10.18	4.08	3.45	2.59	1.15	1.63	0.37	1.24	0.19	0.79	0.06	0.54	0.03	0.36	0.01				
9	7.16	12.66	4.59	4.30	2.92	1.43	1.83	0.46	1.40	0.24	0.89	0.08	0.61	0.03	0.41	0.01				
10	7.95	15.38	5.10	5.22	3.24	1.74	2.04	0.56	1.55	0.29	0.99	0.10	0.68	0.04	0.45	0.01	0.27	0.00		
11	8.75	18.35	5.61	6.23	3.57	2.07	2.24	0.67	1.71	0.35	1.09	0.12	0.74	0.05	0.50	0.02	0.30	0.01		
12	9.55	21.56	6.12	7.32	3.89	2.43	2.44	0.79	1.87	0.41	1.19	0.14	0.81	0.05	0.55	0.02	0.33	0.01		
14	11.14	28.69	7.14	9.74	4.54	3.24	2.85	1.05	2.18	0.54	1.39	0.18	0.95	0.07	0.64	0.03	0.38	0.01		
16	12.73	36.74	8.16	12.47	5.19	4.15	3.26	1.34	2.49	0.70	1.59	0.23	1.08	0.09	0.73	0.04	0.44	0.01		
18	14.32	45.69	9.18	15.51	5.84	5.16	3.67	1.67	2.80	0.87	1.79	0.29	1.22	0.12	0.82	0.04	0.49	0.01		
20	15.91	55.54	10.20	18.86	6.49	6.27	4.08	2.03	3.11	1.05	1.99	0.35	1.36	0.14	0.91	0.05	0.55	0.02		
22	17.50	66.26	11.23	22.50	7.14	7.48	4.48	2.42	3.42	1.25	2.19	0.42	1.49	0.17	1.00	0.06	0.61	0.02		
24	19.10	77.84	12.25	26.43	7.79	8.79	4.89	2.84	3.74	1.47	2.39	0.50	1.63	0.20	1.10	0.08	0.66	0.02		
26			13.27	30.65	8.44	10.19	5.30	3.29	4.05	1.71	2.59	0.58	1.76	0.23	1.19	0.09	0.72	0.03		
28			14.29	35.16	9.09	11.69	5.71	3.78	4.36	1.96	2.79	0.66	1.90	0.26	1.28	0.10	0.77	0.03	0.35	0.00
30			15.31	39.95	9.74	13.29	6.12	4.29	4.67	2.23	2.99	0.75	2.04	0.30	1.37	0.11	0.83	0.03	0.38	0.01
35			17.86	53.15	11.36	17.68	7.14	5.71	5.45	2.96	3.48	1.00	2.38	0.39	1.60	0.15	0.97	0.04	0.44	0.01
40					12.98	22.64	8.16	7.31	6.23	3.80	3.98	1.28	2.72	0.51	1.83	0.19	1.11	0.06	0.51	0.01
45					14.61	28.15	9.18	9.10	7.01	4.72	4.48	1.59	3.06	0.63	2.06	0.24	1.24	0.07	0.57	0.01
50					16.23	34.22	10.20	11.06	7.79	5.74	4.98	1.94	3.40	0.76	2.29	0.29	1.38	0.09	0.64	0.01
55					17.85	40.83	11.22	13.19	8.57	6.85	5.48	2.31	3.74	0.91	2.52	0.35	1.52	0.10	0.70	0.02
60					19.48	47.97	12.24	15.50	9.35	8.04	5.98	2.71	4.08	1.07	2.75	0.41	1.66	0.12	0.76	0.02
65							13.26	17.97	10.13	9.33	6.48	3.15	4.42	1.24	2.98	0.48	1.80	0.14	0.83	0.02
70							14.28	20.62	10.90	10.70	6.97	3.61	4.76	1.42	3.21	0.55	1.94	0.16	0.89	0.02
75							15.30	23.43	11.68	12.16	7.47	4.10	5.10	1.62	3.44	0.62	2.08	0.18	0.96	0.03
80							16.32	26.40	12.46	13.71	7.97	4.62	5.44	1.82	3.67	0.70	2.22	0.21	1.02	0.03
85							17.34	29.54	13.24	15.33	8.47	5.17	5.78	2.04	3.89	0.78	2.35	0.23	1.08	0.04
90							18.36	32.84	14.02	17.05	8.97	5.75	6.12	2.27	4.12	0.87	2.49	0.26	1.15	0.04
95							19.38	36.30	14.80	18.84	9.47	6.35	6.46	2.51	4.35	0.96	2.63	0.28	1.21	0.04
100									15.58	20.72	9.96	6.99	6.80	2.76	4.58	1.06	2.77	0.31	1.28	0.05
110									17.14	24.72	10.96	8.34	7.48	3.29	5.04	1.26	3.05	0.37	1.40	0.06
120									18.70	29.04	11.96	9.79	8.16	3.87	5.50	1.48	3.33	0.44	1.53	0.07
130											12.96	11.36	8.84	4.48	5.96	1.72	3.60	0.51	1.66	0.08
140											13.95	13.03	9.52	5.14	6.42	1.97	3.88	0.58	1.79	0.09
150											14.95	14.81	10.20	5.84	6.88	2.24	4.16	0.66	1.92	0.10
160											15.95	16.69	10.88	6.59	7.34	2.53	4.44	0.74	2.04	0.11
170											16.94	18.67	11.56	7.37	7.79	2.83	4.71	0.83	2.17	0.13
180											17.94	20.75	12.24	8.19	8.25	3.14	4.99	0.93	2.30	0.14
190											18.94	22.94	12.92	9.05	8.71	3.47	5.27	1.02	2.43	0.16
200											19.93	25.23	13.60	9.95	9.17	3.82	5.55	1.12	2.56	0.17
225													15.30	12.38	10.32	4.75	6.24	1.40	2.88	0.21
250													17.00	15.05	11.47	5.77	6.93	1.70	3.20	0.26
275													18.70	17.95	12.61	6.89	7.63	2.03	3.52	0.31
300															13.76	8.09	8.32	2.38	3.84	0.36
325															14.91	9.39	9.02	2.76	4.16	0.42
350															16.05	10.77	9.71	3.17	4.48	0.48
375															17.20	12.23	10.40	3.60	4.80	0.55
400															18.35	13.79	11.10	4.06	5.12	0.62
425															19.49	15.42	11.79	4.54	5.44	0.69
450																	12.49	5.05	5.76	0.77
475																	13.18	5.58	6.08	0.85
500																	13.87	6.14	6.40	0.94
550																	15.26	7.32	7.04	1.12
600																	16.65	8.60	7.68	1.31

Note: Shaded areas of the chart indicate velocities over 5 feet per second (FPS). Use with caution.

Type K Copper Water Tube

SIZES: 1/2" – 3" **FLOW:** 1 – 600 GPM **PSI LOSS:** Per 100' of tube (PSI/100 FT) **C = 140**

SIZE	1/2"		5/8"		3/4"		1"		1 1/4"		1 1/2"		2"		2 1/2"		3"	
OD	0.625		0.750		0.875		1.125		1.375		1.625		2.125		2.625		3.125	
ID	0.527		0.652		0.745		0.995		1.245		1.481		1.959		2.435		2.907	
WALL THK.	0.049		0.049		0.065		0.065		0.065		0.072		0.083		0.095		0.109	
FLOW G. P. M.	Velocity FPS	psi Loss	Velocity FPS	psi Loss	Velocity FPS	psi Loss	Velocity FPS	psi Loss	Velocity FPS	psi Loss	Velocity FPS	psi Loss	Velocity FPS	psi Loss	Velocity FPS	psi Loss	Velocity FPS	psi Loss
1	1.45	1.09	0.95	0.39	0.73	0.20	0.41	0.05	0.26	0.02	0.18	0.01	0.10	0.00				
2	2.93	3.94	1.91	1.40	1.47	0.73	0.82	0.18	0.52	0.06	0.37	0.03	0.21	0.01				
3	4.40	8.35	2.87	2.974	2.20	1.55	1.23	0.38	0.78	0.13	0.55	0.05	0.31	0.01	0.20	0.00		
4	5.87	14.23	3.83	5.05	2.94	2.64	1.64	0.65	1.05	0.22	0.74	0.09	0.42	0.02	0.27	0.01	0.19	0.00
5	7.34	21.51	4.79	7.64	3.67	3.99	2.06	0.98	1.31	0.33	0.93	0.14	0.53	0.04	0.34	0.01	0.24	0.01
6	8.81	30.15	5.75	10.70	4.41	5.60	2.47	1.37	1.57	0.46	1.11	0.20	0.63	0.05	0.41	0.02	0.28	0.01
7	10.28	40.11	6.71	14.24	5.14	7.44	2.88	1.82	1.84	0.61	1.30	0.26	0.74	0.07	0.48	0.02	0.33	0.01
8	11.75	51.37	7.67	18.24	5.88	9.53	3.29	2.33	2.10	0.78	1.48	0.34	0.85	0.09	0.55	0.03	0.38	0.01
9	13.22	63.89	8.63	22.68	6.61	11.86	3.70	2.90	2.36	0.97	1.67	0.42	0.95	0.11	0.61	0.04	0.43	0.02
10	14.69	77.66	9.59	27.57	7.35	14.41	4.12	3.53	2.63	1.18	1.86	0.51	1.06	0.13	0.68	0.05	0.48	0.02
11	16.15	92.65	10.55	32.89	8.08	17.19	4.53	4.21	2.89	1.41	2.04	0.61	1.16	0.16	0.75	0.05	0.53	0.02
12	17.62	108.85	11.51	38.64	8.82	20.20	4.94	4.94	3.15	1.66	2.23	0.71	1.27	0.18	0.82	0.06	0.57	0.03
14			13.43	51.41	10.29	26.87	5.76	6.57	3.68	2.21	2.60	0.95	1.48	0.24	0.95	0.08	0.67	0.04
16			15.35	65.83	11.76	34.41	6.59	8.42	4.21	2.83	2.97	1.22	1.70	0.31	1.10	0.11	0.77	0.05
18			17.27	81.88	13.23	42.80	7.41	10.47	4.73	3.52	3.34	1.51	1.91	0.39	1.23	0.13	0.86	0.06
20			19.19	99.53	14.70	52.02	8.24	12.73	5.26	4.28	3.72	1.84	1.12	0.47	1.37	0.16	0.96	0.07
22					16.17	62.06	9.06	15.18	5.79	5.10	4.09	2.19	2.33	0.56	1.51	0.20	1.06	0.08
24					17.64	72.92	9.89	17.84	6.31	5.99	4.46	2.58	2.55	0.66	1.65	0.23	1.15	0.10
26					19.11	84.57	10.71	20.69	6.84	6.95	4.83	2.99	2.76	0.77	1.78	0.27	1.25	0.11
28							11.53	23.73	7.37	7.98	5.20	3.43	2.97	0.88	1.92	0.30	1.35	0.13
30							12.36	26.97	7.89	9.06	5.58	3.89	3.18	1.00	2.06	0.35	1.44	0.15
35							14.42	35.88	9.21	12.06	6.51	5.18	3.72	1.33	2.40	0.46	1.68	0.19
40							16.48	45.95	10.52	15.44	7.44	6.63	4.25	1.70	2.75	0.59	1.93	0.25
45							18.54	57.15	11.84	19.20	8.37	8.25	4.78	2.12	3.00	0.73	2.17	0.31
50									13.16	23.34	9.30	10.03	5.31	2.57	3.44	0.89	2.41	0.38
55									14.47	27.85	10.23	11.97	5.84	3.07	3.78	1.06	2.65	0.45
60									15.79	32.71	11.16	14.06	6.37	3.60	4.12	1.25	2.89	0.53
65									17.10	37.94	12.09	16.31	6.91	4.18	4.47	1.45	3.13	0.61
70									18.42	43.52	13.02	18.70	7.44	4.80	4.81	1.66	3.37	0.70
75									19.74	49.45	13.95	21.25	7.97	5.45	5.16	1.89	3.62	0.80
80											14.88	23.95	8.50	6.14	5.50	2.13	3.86	0.90
85											15.81	26.80	9.03	6.87	5.84	2.38	4.10	1.01
90											16.74	29.79	9.56	7.64	6.19	2.65	4.34	1.12
95											17.67	32.93	10.09	8.44	6.53	2.93	4.58	1.24
100											18.60	36.21	10.63	9.28	6.88	3.22	4.82	1.36
110													11.69	11.08	7.56	3.84	5.31	1.62
120													12.75	13.01	8.25	4.52	5.79	1.91
130													13.82	15.09	8.94	5.24	6.27	2.21
140													14.88	17.31	9.63	6.01	6.75	2.54
150													15.94	19.67	10.32	6.83	7.24	2.88
160													17.01	22.17	11.00	7.69	7.72	3.25
170													18.07	24.81	11.69	8.61	8.20	3.64
180													19.13	27.58	12.38	9.57	8.69	4.04
190															13.07	10.58	9.17	4.47
200															13.76	11.63	9.65	4.91
225															15.48	14.47	10.86	6.11
250															17.20	17.58	12.07	7.43
275															18.92	20.98	13.27	8.86
300																	14.48	10.41
325																	15.69	12.07
350																	16.89	13.85
375																	18.10	15.73
400																	19.31	17.73
425																		
450																		
475																		
500																		
550																		
600																		

Note: Shaded areas of the chart indicate velocities over 7 feet per second (FPS). Use with caution.

Charts

Polyethylene (PE) SDR-Pressure Rated Tube

SIZES: 1/2" – 6" **FLOW:** 1 – 600 GPM **PSI LOSS:** Per 100' of tube (PSI/100 FT) **C = 140** (2306, 3206, 3306) SDR 7, 9, 11.5, 15

SIZE	1/2"		3/4"		1"		1 1/4"		1 1/2"		2"		2 1/2"		3"		4"		6"	
ID	0.622		0.824		1.049		1.380		1.610		2.067		2.469		3.068		4.026		6.065	
FLOW G. P. M.	Velocity FPS	psi Loss	Velocity FPS	psi Loss	Velocity FPS	psi Loss	Velocity FPS	psi Loss	Velocity FPS	psi Loss	Velocity FPS	psi Loss	Velocity FPS	psi Loss	Velocity FPS	psi Loss	Velocity FPS	psi Loss	Velocity FPS	psi Loss
1	1.05	0.49	0.60	0.12	0.37	0.04	0.21	0.01	0.15	0.00	0.09	0.00								
2	2.10	1.76	1.20	0.45	0.74	0.14	0.42	0.04	0.31	0.02	0.19	0.01								
3	3.16	3.73	1.80	0.95	1.11	0.29	0.64	0.08	0.47	0.04	0.28	0.01	0.20	0.00						
4	4.21	6.35	2.40	1.62	1.48	0.50	0.85	0.13	0.62	0.06	0.38	0.02	0.26	0.01						
5	5.27	9.60	3.00	2.44	1.85	0.76	1.07	0.20	0.78	0.09	0.47	0.03	0.33	0.01	0.21	0.00				
6	6.32	13.46	3.60	3.43	2.22	1.06	1.28	0.28	0.94	0.13	0.57	0.04	0.40	0.02	0.26	0.01				
7	7.38	17.91	4.20	4.56	2.59	1.41	1.49	0.37	1.10	0.18	0.66	0.05	0.46	0.02	0.30	0.01				
8	8.43	22.93	4.80	5.84	2.96	1.80	1.71	0.474	1.25	0.22	0.76	0.07	0.53	0.03	0.34	0.03				
9	9.49	28.52	5.40	7.26	3.33	2.24	1.92	0.59	1.41	0.28	0.85	0.08	0.60	0.03	0.39	0.01				
10	10.54	34.67	6.00	8.82	3.70	2.73	2.14	0.72	1.57	0.34	0.95	0.10	0.66	0.04	0.43	0.01				
11	11.60	41.36	6.00	10.53	4.07	3.25	2.35	0.86	1.73	0.40	1.05	0.12	0.73	0.05	0.47	0.02	0.27	0.00		
12	12.65	48.60	7.21	12.37	4.44	3.82	2.57	1.01	1.88	0.48	1.14	0.14	0.80	0.06	0.52	0.02	0.30	0.01		
14	14.76	64.65	8.41	16.46	5.19	5.08	2.99	1.34	2.20	0.63	1.33	0.19	0.93	0.08	0.60	0.03	0.35	0.01		
16	16.87	82.79	9.61	21.07	5.93	6.51	3.42	1.71	2.51	0.81	1.52	0.24	1.07	0.10	0.69	0.04	0.40	0.01		
18	18.89	102.97	10.81	26.21	6.67	8.10	3.85	2.13	2.83	1.01	1.71	0.30	1.20	0.13	0.78	0.04	0.45	0.01		
20			12.01	31.86	7.41	9.84	4.28	2.59	3.14	1.22	1.90	0.36	1.33	0.15	0.86	0.05	0.50	0.01		
22			13.21	38.01	8.15	11.74	4.71	3.09	3.46	1.46	2.10	0.43	1.47	0.18	0.95	0.06	0.55	0.02		
24			14.42	44.65	8.89	13.79	5.14	3.63	3.77	1.72	2.29	0.51	1.60	0.21	1.04	0.07	0.60	0.02		
26			15.62	47.79	9.64	16.00	5.57	4.21	4.09	1.99	2.48	0.59	1.74	0.25	1.12	0.09	0.65	0.02		
28			16.82	59.41	10.38	18.35	5.99	4.83	4.40	2.28	2.67	0.68	1.87	0.29	1.21	0.10	0.70	0.03		
30			18.02	67.50	11.12	20.85	6.42	5.49	4.72	2.59	2.86	0.77	2.00	0.32	1.30	0.11	0.75	0.03	0.33	0.00
35					12.97	27.74	7.49	7.31	5.50	3.45	3.34	1.02	2.34	0.43	1.51	0.15	0.88	0.04	0.38	0.01
40					14.83	35.53	8.56	9.36	6.29	4.42	3.81	1.31	2.67	0.55	1.73	0.19	1.00	0.05	0.44	0.01
45					16.68	44.19	9.64	11.64	7.08	5.50	4.29	1.63	3.01	0.69	1.95	0.24	1.13	0.06	0.49	0.01
50					18.53	53.71	10.71	14.14	7.87	6.68	4.77	1.98	3.34	0.83	2.16	0.29	1.25	0.08	0.55	0.01
55							11.78	16.87	8.65	7.97	5.25	2.36	3.68	1.00	2.38	0.35	1.38	0.09	0.61	0.01
60							12.85	19.82	9.44	9.36	5.72	2.78	4.01	1.17	2.60	0.41	1.51	0.11	0.66	0.01
65							13.92	22.99	10.23	10.86	6.20	3.22	4.35	1.36	2.81	0.47	1.63	0.13	0.72	0.02
70							14.99	26.37	11.01	12.46	6.68	3.69	4.68	1.56	3.03	0.54	1.76	0.14	0.77	0.02
75							16.06	29.97	11.80	14.16	7.16	4.20	5.01	1.77	3.25	0.61	1.88	0.16	0.83	0.02
80							17.13	33.77	12.59	15.95	7.63	4.73	5.35	1.99	3.46	0.69	2.01	0.18	0.88	0.03
85							18.21	37.79	13.37	17.85	8.11	5.29	5.68	2.23	3.68	0.77	2.13	0.21	0.94	0.03
90							19.28	42.01	14.16	19.84	8.59	5.88	6.02	2.48	3.90	0.86	2.26	0.23	0.99	0.03
95									14.95	21.93	9.07	6.50	6.35	2.74	4.11	0.95	2.39	0.25	1.05	0.03
100									15.74	24.12	9.54	7.15	6.69	3.01	4.33	1.05	2.51	0.28	1.10	0.04
110									17.31	28.77	10.50	8.53	7.36	3.59	4.76	1.25	2.76	0.33	1.22	0.05
120									18.88	33.80	11.45	10.02	8.03	4.22	5.20	1.47	3.02	0.39	1.33	0.05
130											12.41	11.62	8.70	4.90	5.63	1.70	3.27	0.45	1.44	0.06
140											13.36	13.33	9.37	5.62	6.06	1.95	3.52	0.52	1.55	0.07
150											14.32	15.15	10.03	6.38	6.50	2.22	3.77	0.59	1.66	0.08
160											15.27	17.08	10.70	7.19	6.93	2.50	4.02	0.67	1.77	0.09
170											16.23	19.11	11.37	8.05	7.36	2.80	4.27	0.75	1.88	0.10
180											17.18	21.24	12.04	8.95	7.08	3.11	4.53	0.83	1.99	0.11
190											18.14	23.48	12.71	9.89	8.23	3.44	4.78	0.92	2.10	0.12
200											19.09	25.81	13.38	10.87	8.66	3.78	5.03	1.01	2.21	0.14
225													15.05	13.52	9.75	4.70	5.66	1.25	2.49	0.17
250													16.73	16.44	10.83	5.71	6.29	1.52	2.77	0.21
275													18.40	19.61	11.92	6.82	6.92	1.82	3.05	0.25
300															13.00	8.01	7.55	2.13	3.32	0.29
325															14.08	9.29	8.18	2.48	3.60	0.34
350															15.17	10.65	8.81	2.84	3.88	0.39
375															16.25	12.10	9.43	3.23	4.15	0.44
400															17.33	13.64	10.06	3.64	4.43	0.50
425															18.42	15.26	10.69	4.07	4.71	0.55
450															19.50	16.97	11.32	4.52	4.99	0.62
475																	11.95	5.00	5.26	0.68
500																	12.58	5.50	5.54	0.75
550																	13.84	6.56	6.10	0.89
600																	15.10	7.70	6.65	1.05

Note: Shaded areas of the chart indicate velocities over 5 feet per second (FPS). Use with caution.

Schedule 40 Standard Steel Pipe

SIZES: 1/2" – 6" **FLOW:** 1 – 600 GPM **PSI LOSS:** Per 100' of pipe (PSI/100 FT) **C = 100 15**

SIZE	1/2"		3/4"		1"		1 1/4"		1 1/2"		2"		2 1/2"		3"		4"		6"	
OD	0.840		1.050		1.315		1.660		1.900		2.375		2.875		3.500		4.500		6.625	
ID	0.622		0.824		1.049		1.380		1.610		2.067		2.469		3.068		4.026		6.065	
WALL THK.	0.109		0.113		0.133		0.140		0.145		0.154		0.203		0.216		0.237		0.280	
FLOW G. P. M.	Velocity FPS	psi Loss	Velocity FPS	psi Loss	Velocity FPS	psi Loss	Velocity FPS	psi Loss	Velocity FPS	psi Loss	Velocity FPS	psi Loss	Velocity FPS	psi Loss	Velocity FPS	psi Loss	Velocity FPS	psi Loss	Velocity FPS	psi Loss
1	1.05	0.91	0.60	0.23	0.37	0.07	0.21	0.02	0.15	0.01	0.09	0.00								
2	2.10	3.28	1.20	0.84	0.74	0.26	0.42	0.07	0.31	0.03	0.19	0.01	0.13	0.00						
3	3.16	6.95	1.80	1.77	1.11	0.55	0.64	0.14	0.47	0.07	0.28	0.02	0.20	0.01	0.13	0.00				
4	4.21	11.85	2.40	3.02	1.48	0.93	0.85	0.25	0.62	0.12	0.38	0.03	0.26	0.01	0.17	0.01				
5	5.27	17.91	3.00	4.56	1.85	1.41	1.07	0.37	0.78	0.18	0.47	0.05	0.33	0.02	0.21	0.01				
6	6.32	25.10	3.60	6.39	2.22	1.97	1.28	0.52	0.94	0.25	0.57	0.07	0.40	0.03	0.26	0.01				
7	7.38	33.40	4.20	8.50	2.59	2.63	1.49	0.69	1.10	0.33	0.66	0.10	0.46	0.04	0.30	0.01				
8	8.43	42.77	4.80	10.89	2.96	3.36	1.71	0.89	1.25	0.42	0.76	0.12	0.53	0.05	0.34	0.02	0.20	0.00		
9	9.49	53.19	5.40	13.54	3.33	4.18	1.92	1.10	1.41	0.52	0.85	0.15	0.60	0.06	0.39	0.02	0.22	0.01		
10	10.54	64.65	6.00	16.46	3.70	5.08	2.14	1.34	1.57	0.63	0.95	0.19	0.66	0.08	0.43	0.03	0.25	0.01		
11	11.60	77.13	6.60	19.63	4.07	6.07	2.35	1.60	1.73	0.75	1.05	0.22	0.73	0.09	0.47	0.03	0.27	0.01		
12	12.65	90.62	7.21	23.07	4.44	7.13	2.57	1.88	1.88	0.89	1.14	0.26	0.80	0.11	0.52	0.04	0.30	0.01		
14	14.76	20.56	8.41	30.69	5.19	9.48	2.99	2.50	2.20	1.18	1.33	0.35	0.93	0.15	0.60	0.05	0.35	0.01		
16	16.87	54.39	9.61	39.30	5.93	12.14	3.42	3.20	2.51	1.51	1.52	0.45	1.07	0.19	0.69	0.07	0.40	0.02		
18	18.89	92.02	10.81	48.88	6.67	15.10	3.85	3.98	2.83	1.88	1.71	0.56	1.20	0.23	0.78	0.08	0.45	0.02		
20			12.01	59.41	7.41	18.35	4.28	4.83	3.14	2.28	1.90	0.68	1.33	0.29	0.86	0.10	0.50	0.03		
22			13.21	70.88	8.15	21.90	4.71	5.77	3.46	2.72	2.10	0.81	1.47	0.34	0.95	0.12	0.55	0.03	0.24	0.00
24			14.42	83.27	8.89	25.72	5.14	6.77	3.77	3.20	2.29	0.95	1.60	0.40	1.04	0.14	0.60	0.04	0.26	0.01
26			15.62	96.57	9.64	29.83	5.57	7.86	4.09	3.71	2.48	1.10	1.74	0.46	1.12	0.16	0.65	0.04	0.28	0.01
28			16.82	110.8	10.38	34.22	5.99	9.01	4.40	4.26	2.67	1.26	1.87	0.53	1.21	0.18	0.70	0.05	0.31	0.01
30			18.02	125.9	11.12	38.89	6.42	10.24	4.72	4.84	2.86	1.43	2.00	0.60	1.30	0.21	0.75	0.06	0.33	0.01
35					12.97	51.74	7.49	13.62	5.50	6.44	3.34	1.91	2.34	0.80	1.51	0.28	0.88	0.07	0.38	0.01
40					14.83	66.25	8.56	17.45	6.29	8.24	3.81	2.44	2.67	1.03	1.73	0.36	1.00	0.10	0.44	0.01
45					16.68	82.40	9.64	21.70	7.08	10.25	4.29	3.04	3.01	1.28	1.95	0.44	1.13	0.12	0.49	0.02
50					18.53	100.2	10.71	26.37	7.87	12.46	4.77	3.69	3.34	1.56	2.16	0.54	1.25	0.14	0.55	0.02
55							11.78	31.47	8.65	14.86	5.25	4.41	3.68	1.86	2.38	0.65	1.38	0.17	0.61	0.02
60							12.85	36.97	9.44	17.46	5.72	5.18	4.01	2.18	2.60	0.76	1.51	0.20	0.66	0.03
65							13.92	42.88	10.23	20.25	6.20	6.00	4.35	2.53	2.81	0.88	1.63	0.23	0.72	0.03
70							14.99	49.18	11.01	23.23	6.68	6.89	4.68	2.90	3.03	1.01	1.76	0.27	0.77	0.04
75							16.06	55.89	11.80	26.40	7.16	7.83	5.01	3.30	3.25	1.15	1.88	0.31	0.83	0.04
80							17.13	62.98	12.59	29.75	7.63	8.82	5.35	3.72	3.46	1.29	2.01	0.34	0.88	0.05
85							18.21	70.47	13.37	33.29	8.11	9.87	5.68	4.16	3.68	1.44	2.13	0.39	0.94	0.05
90							19.28	78.33	14.16	37.00	8.59	10.97	6.02	4.62	3.90	1.61	2.26	0.43	0.99	0.06
95									14.95	40.90	9.07	12.13	6.35	5.11	4.11	1.78	2.39	0.47	1.05	0.06
100									15.74	44.97	9.54	13.33	6.69	5.62	4.33	1.95	2.51	0.52	1.10	0.07
110									17.31	53.66	10.50	15.91	7.36	6.7	4.76	2.33	2.76	0.62	1.22	0.08
120									18.88	63.04	11.45	18.69	8.03	7.87	5.20	2.74	3.02	0.73	1.33	0.10
130											12.41	21.68	8.70	9.13	5.63	3.17	3.27	0.85	1.44	0.12
140											13.36	24.87	9.37	10.47	6.06	3.64	3.52	0.97	1.55	0.13
150											14.32	28.26	10.03	11.90	6.50	4.14	3.77	1.10	1.66	0.15
160											15.27	31.84	10.70	13.41	6.93	4.66	4.02	1.24	1.77	0.17
170											16.23	35.63	11.37	15.01	7.36	5.22	4.27	1.39	1.88	0.19
180											17.18	39.61	12.04	16.68	7.80	5.80	4.53	1.55	1.99	0.21
190											18.14	43.78	12.71	18.44	8.23	6.41	4.78	1.71	2.10	0.23
200											19.09	48.14	13.38	20.28	8.66	7.05	5.03	1.88	2.21	0.26
225													15.08	25.22	9.75	8.76	5.66	2.34	2.49	0.32
250													16.73	30.65	10.83	10.65	6.29	2.84	2.77	0.39
275													18.40	36.57	11.92	12.71	6.92	3.39	3.05	0.46
300															13.00	14.93	7.55	3.98	3.32	0.54
325															14.08	17.32	8.18	4.62	3.60	0.63
350															15.17	19.87	8.81	5.30	3.88	0.72
375															16.25	22.57	9.43	6.02	4.15	0.82
400															17.33	25.44	10.06	6.78	4.43	0.92
425															18.42	28.46	10.69	7.59	4.71	1.03
450															19.50	31.64	11.32	8.43	4.99	1.15
475																	11.95	9.32	5.26	1.27
500																	12.58	10.25	5.54	1.40
550																	13.84	12.23	6.10	1.67
600																	15.10	14.37	6.65	1.96

Note: Shaded areas of the chart indicate velocities over 7 feet per second (FPS). Use with caution.

Warranty



It's our best warranty ever, and no one else offers anything better.

K-Rain® products are designed to stand the test of time. But should something happen, we've got you covered with our industry-leading 3/7 Warranty. **It's our best warranty ever, and no one else offers anything better.**

There's no trickery, no hidden fine print. It's honest and fair, plain and simple. Electronics, Rotary Nozzles and Drip have a 3-year warranty. Rotors, sprays, valves and everything else has a 7-year warranty.

That's not just a huge added value, that's a whole lot of peace of mind, right there.

3-Year Warranty: Electronics, rotary nozzles, and drip

7-year Warranty: Everything else

K-Rain® **professional** line of products purchased at authorized K-Rain® distributorships or online, carry a limited warranty from the date of manufacture as stated in the specified period of time on the opposite page. During this period, K-Rain® will repair or replace (at the discretion of K-Rain) the product or any part if the product is found to be defective as to workmanship or material.

This warranty does not extend to damage of a K-Rain® product resulting from misuse, neglect or abuse, normal wear and tear or accidents, to exterior appearance or color or due to improper installation.

This warranty extends only to an original user of a K-Rain® product.

IN NO EVENT SHALL K-RAIN® BE LIABLE FOR INCIDENTAL OR CONSEQUENTIAL DAMAGES. ALL IMPLIED WARRANTIES ARE LIMITED IN DURATION OF THE SPECIFIED YEARS FOLLOWING THE DATE OF MANUFACTURE UNLESS INDICATED OTHERWISE.

Some U.S. states do not permit the exclusion or limitation of incidental or consequential damages or of implied warranties. Therefore, the above exclusions or limitations may not apply to you. If a defect arises in a K-Rain® product within the warranty period, you should promptly contact your K-Rain® installer, distributor or K-RAIN® MANUFACTURING CORPORATION.

This warranty gives you specific legal rights, and you may also have other rights which vary from state to state. If you have any questions concerning the warranty or its application, please contact K-Rain®.

3 YEARS	Controllers	SiteMaster
		Pro EX 2.0
		PRO-LC
		RPS™46
		K-Rain® BLUE®
		Controller Accessories
	Rain Sensors	Hardwired Rain Sensor
		Hardwired Rain/Freeze Sensor
		Wireless Rain Sensors
		Wireless Rain/Freeze Sensors
		Universal Wireless Rain/Freeze Sensors
	Rotary Nozzles	Rotary Nozzle Series
		Fully Adjustable Rotary Nozzles
	Drip Irrigation	Dripline
		Drip Fittings
		Drip Control Zone Kits
		Pressure Regulators
	Single Station Controllers	2100 Single Station Controllers
		2200 Short Duration Single Station Controllers
		2500 Rain Switch Ready Controllers
Pump Start Relays	Pump Start Relays	

7 YEARS	Rotors	MiniPro®
		RPS™ 50
		RPS™ 75
		RPS™ 75i
		RPS™ Select
		ProPlus®
		SuperPro®
		ProSport®
		Rotor Accessories
	Sprays	Pro-S™
		NP Sprays
		K-Sprays
		Spray Accessories
	Nozzles	KV Nozzles
		KVF Nozzles
		Fixed Pattern Nozzles
		Bubblers
	Valves	ProSeries 100
		ProSeries 150
		ProSeries 200
		Valve Accessories
	Indexing Valves	4000 Series
		6000 Series



Down here. Doing. It. Right

K-Rain® Manufacturing Corp.
1640 Australian Avenue | Riviera Beach, FL 33404 USA
561.844.1002 | Fax: 561.842.9493 | 1.800.735.7246

© K-Rain® Manufacturing Corporation
AN ISO 9001 CERTIFIED COMPANY

www.krain.com